

SUPPLEMENTAL INFORMATION SHEET FOR QPL SAE-AS50151™

---

QUALIFICATIONS HAVE BEEN VALIDATED  
(Frequency: 3 Years)  
BY VERIFICATION TESTING

QPL-50151-29

6 March 2025

---

SUPPLEMENTAL INFORMATION SHEET FOR QUALIFIED PRODUCTS LIST

OF

PRODUCTS QUALIFIED UNDER SAE AEROSPACE STANDARD

**AS50151**

**CONNECTORS, ELECTRICAL, CIRCULAR THREADED, AN TYPE,  
GENERAL SPECIFICATION FOR**

This list has been prepared for use by or for the Government in the acquisition of products covered by the subject non-Government standard and such listing of a product is not intended to and does not connote endorsement of the product by the Department of Defense. All products listed herein have been qualified under the requirements for the product as specified in the latest adopted issue of the applicable non-Government standard. This list is subject to change without notice; revision or amendment of this list will be issued as necessary. The listing of a product does not release the manufacturer from compliance with the non-Government standard requirements.

The activity responsible for this qualified products list and for qualification approval is the Naval Air Systems Command, AB43300, 48298 Shaw Rd., Building 1461, Patuxent River, Maryland 20670-1900. Manufacturer's full name, cage number, office and plant addresses are listed at the end of this QPL.

THIS DOCUMENT IS AN OFFICIAL SUPPLEMENTAL INFORMATION SHEET OF THE PRODUCTS TRANSFORMED TO AN EQUIVALENT QUALIFICATION DATA SET (QDS). USERS OF THIS DOCUMENT MUST VISIT THE QUALIFIED PRODUCTS DATABASE (QPD) TO VERIFY QUALIFICATION INFORMATION. PLEASE VISIT [HTTP://ASSIST.DAPS.DLA.MIL/ONLINE/START/](http://assist.daps.dla.mil/online/start/) TO ACCESS INFORMATION. YOU MUST HAVE A USERNAME AND PASSWORD TO ENTER SITE. ONCE LOGGED IN CHOOSE "QPD" FROM THE SIDE MENU. YOU CAN SEARCH BY QPL NUMBER, DOCUMENT NUMBER, GOVERNING SPEC, TITLE, FSC, GOVERNMENT DESIGNATION, NON-GOVERNMENT (NGS) DESIGNATION, MANUFACTURER DESIGNATION, OR SOURCE NAME.

Applicable Specification Sheets

The following is a list of the applicable qualified SAE-AS specification sheets which use AS50151 as a procurement specification.

SERIES I - CONNECTORS, SOLDER CONTACT

<u>Specification</u>	<u>P/N Designation</u>	
AS25183	MS25183*	Connector, Plug, Electric, Potting Seal, Solder Contact, AN Type.
AS31001	MS3100*	Connector, Receptacle, Electric, Wall Mounting, Solder Contacts, AN Type.
AS31011	MS3101*	Connector, Receptacle, Electric, Cable Connecting, Solder Contacts, AN Type.
AS31021	MS3102*	Connector, Receptacle, Electric, Box Mounting, Solder Contacts, AN Type.
AS31031	MS3103*	Connector, Receptacle, Electric, Potting Seal, Solder Contacts, AN Type.
AS31061	MS3106*	Connector, Plug, Electric, Straight, Solder Contacts, AN Type.
AS31071	MS3107*	Connector, Plug, Electric, Quick Disconnect.
AS31081	MS3108*	Connectors, Plug, Electric, Solder Contacts, 90 Degree, AN Type.
AS34361	MS3436*	Connector, Plug, Electric, Solder Contact, Utility.
AS35071	MS3507	Connector, Plug, Electric, Solder Contact, Quick Disconnect, Utility.

\* NOT FOR NAVAIR USE

SERIES II - CONNECTORS, CRIMP CONTACT, FRONT RELEASE

<u>Specification</u>	<u>P/N Designation</u>	
AS34001	MS3400*	Connector, Receptacle, Electric, Wall Mounting, Front Release, Crimp Contact, AN Type.
AS34011	MS3401*	Connector, Receptacle, Electric, Cable Connecting, Front Release, Crimp Contact, AN Type.
AS34021	MS3402*	Connector, Receptacle, Electric, Box Mounting, Front Release, Crimp Contact, AN Type.
AS34041	MS3404*	Connectors, Receptacle, Electric, Jam Nut Mounting, Front Release, Crimp Contact, AN Type.
AS34061	MS3406*	Connectors, Plug, Electric, Front Release, Crimp Contact, AN Type.
AS34081	MS3408	Connector, Plug, Electric, 90° Assembly, Crimp Contact, AN Type.
AS34091	MS3409	Connectors, Plug, Electric, 45° Assembly, Crimp Contact, AN Type.
AS34121	MS3412	Connectors, Receptacle, Electric, Wall Mounting, Front Release, Crimp Contact, AN Type - with Accessory Threads.

\* NOT FOR NAVAIR USE

SERIES III – CONNECTORS, CRIMP CONTACT, REAR RELEASE

<u>Specification</u>	<u>P/N Designation</u>	
AS34501	MS3450	Connector, Receptacle, Electric, Wall Mounting, Rear Release, Crimp Contact, AN Type.
AS34511	MS3451	Connector, Receptacle, Electric, Cable Connecting, Rear Release, Crimp Contact, AN Type.
AS34521	MS3452	Connector, Receptacle, Electric, Box Mounting, Rear Release, Crimp Contact, AN Type.
AS34541	MS3454	Connectors, Receptacle, Electric, Jam Nut Mounting, Rear Release, Crimp Contact, AN Type.
AS34561	MS3456	Connectors, Plug, Electric, Rear Release, Crimp Contact, AN Type.
AS34591	MS3459**	Connector, Plug, Electric, Self-Locking, Coupling Nut, Rear Release, Crimp Contact, AN Type.

\*\* QUALIFICATION BY SIMILARITY IS NOT ALLOWED FOR THE AS34591 PRODUCT

SERIES IV - CONNECTOR ACCESSORIES

<u>Specification</u>	<u>P/N Designation</u>	
AS25042	MS25042	Cover, AS50151 Connector, Plug, AN Type.
AS25043	MS25043	Cover, AS50151 Connector, Receptacle, AN Type.
AS31051	MS3105*	Connector, Receptacle, Electric Dummy Stowage.

\* NOT FOR NAVAIR USE

Qualified Backshell Accessories

The following connector accessories have been superseded by SAE-AS85049, and are no longer listed in QPL-50151.

Cross reference of superseded specifications

<u>Superseded specification</u>	<u>Superseded by</u>
MS3057 (Style B)	SAE-AS85049/1
MS3057 (Style C)	/2
MS3057 (Style A)	/41
MS3057 (Style D)	/42
MS3152	/53
MS3153	/54
MS3154	/55
MS3158	/60
MS3161	/26
MS3188 (Style A)	/8
MS3188 (Style B)	/9
MS3188 (Style C)	/24
MS3189 (Style A)	/6
MS3189 (Style B)	/7
MS3189 (Style C)	/23
MS3415	/43
MS3416 (Style E)	/31
MS3416 (Style G)	/60
MS3417	/52
MS3418	/51
MS3419	/26
MS3437 (Style A)	/10
MS3437 (Style B)	/11
MS3437 (Style C)	/25

For the sake of brevity, part number designations are displayed as shown in the following example:

Part Number Interpretation:

MS3400	A	10-1	XX00	A	10-1
	B	-2		B	-2
		12-5			12-5
MS3401	A	-10	XX01	A	-10

The matrices generate the following fictitious part numbers:

MS3400A10-1	XX00A10-1
A10-2	A10-2
A12-5	A12-5
A12-10	A12-10
MS3400B10-1	XX00B10-1
B10-2	B10-2
B12-5	B12-5
B12-10	B12-10
MS3401A10-1	XX01A10-1
A10-2	A10-2
A12-5	A12-5
A12-10	A12-10

WHERE THE MANUFACTURER'S PART NUMBER LISTING FOR A PARTICULAR MS NUMBER IS LONGER THAN ONE PAGE, THE COMPLETE NUMBER AND TITLE BLOCK WILL NOT BE SHOWN ON THE PAGES THAT FOLLOW. REFER BACK TO THE FIRST PAGE OF THAT LISTING FOR THE MS NUMBERS PERTAINING TO THAT PART NUMBER.

**TABLE OF CONTENTS**

**AS50151 SERIES I - CONNECTORS, SOLDER CONTACT ..... 7**  
MS25183 PART NUMBER EXAMPLE, OPTIONS, AND DESCRIPTIONS ..... 7  
MS25183..... 8  
MS3100 – MS3108 PART NUMBER EXAMPLE, OPTIONS, AND DESCRIPTIONS ..... 19  
MS3100 – MS3108..... 20  
MS3436 PART NUMBER EXAMPLE, OPTIONS, AND DESCRIPTIONS ..... 34  
MS3436..... 34  
MS3507 PART NUMBER EXAMPLE, OPTIONS, AND DESCRIPTIONS ..... 35  
MS3507..... 35

**AS50151 SERIES II - CONNECTORS, CRIMP CONTACT, FRONT RELEASE..... 36**  
MS3400 – MS3412 PART NUMBER EXAMPLE, OPTIONS, AND DESCRIPTIONS ..... 36  
MS3400 – MS3412..... 37

**AS50151 SERIES III - CONNECTORS, CRIMP CONTACT, REAR RELEASE..... 52**  
MS3450 – MS3459 PART NUMBER EXAMPLE, OPTIONS, AND DESCRIPTIONS ..... 52  
MS3450 – MS3459..... 53

**AS50151 SERIES IV - CONNECTOR ACCESSORIES ..... 76**  
MS25042 – MS25043 PART NUMBER EXAMPLE, OPTIONS, AND DESCRIPTIONS 72  
MS25042 – MS25043 ..... 77  
MS3105 PART NUMBER EXAMPLE, OPTIONS, AND DESCRIPTIONS ..... 83  
MS3105..... 84

**Manufacturer’s Full Name, Cage Code, Office and Plant Addresses ..... 86**

PREVIOUS GOVERNMENT DESIGNATION AND NON-GOVERNMENT STANDARDS BODIES DESIGNATION	MANUFACTURER'S DESIGNATION	MANUFACTURER'S NAME AND QUALIFICATION TEST REFERENCE
---	-------------------------------	---

**SAE-AS50151 SERIES I - CONNECTORS, SOLDER CONTACT**

**MS25183 PART NUMBER EXAMPLE, OPTIONS, AND DESCRIPTIONS**

**Reference: latest issue of AS25183**

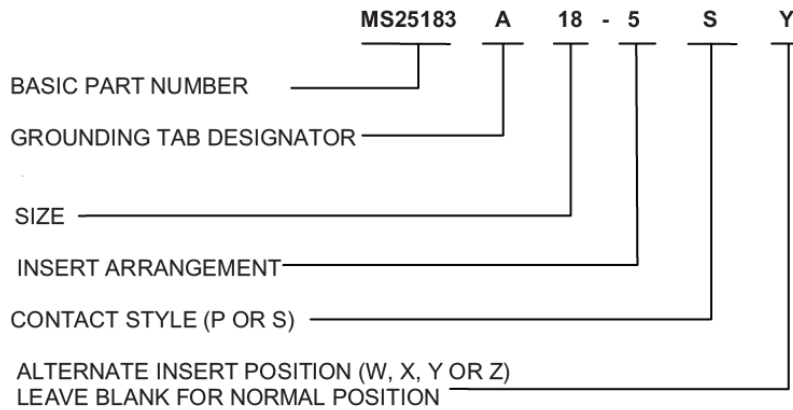

Grounding Tab Designator: Connectors MS25183A are the same as MS25183 except the MS25183A includes a grounding tab. No part number designator is used for the connector without the grounding tab. The grounding tab must provide positive conductivity to shell and be provided with a 6-32 screw and nut for externally grounding pigtails of shielded wire to shell of connector.

Size: Per latest issue of AS50151.

Insert Arrangement: Per latest issue of MIL-STD-1651.

Contact Style 1/:

P = Pin contacts

S = Socket Contacts

Alternate Insert Position 1/: W, X, Y, or Z per latest issue of AS5015. Leave blank for normal position.

1/ All MS25183 base part numbers listed in the following matrices are qualified for all variations of Contact Style and Alternate Insert Position.

PREVIOUS GOVERNMENT DESIGNATION AND NON-GOVERNMENT STANDARDS BODIES DESIGNATION	MANUFACTURER'S DESIGNATION	MANUFACTURER'S NAME AND QUALIFICATION TEST REFERENCE
---	-------------------------------	---

**SAE-AS50151 SERIES I - CONNECTORS, SOLDER CONTACT (continued)**

MS25183	- A	8S-1 10S-2 12S-3 -4 12-5 14S-1 -2 -4 -5 -6 -7 -9 14-3 16S-1 -3 -4 -5 -6 -8 16-2 -7 -9 -10 -11 -12 -13 18-1 -3 -4 -5 -6 -7 -8 -9 -10 -11 -12 -13 -14 18-15 -16	P S	SC06	P A	8S-1 10S-2 12S-3 -4 12-5 14S-1 -2 -4 -5 -6 -7 -9 14-3 16S-1 -3 -4 -5 -6 -8 16-2 -7 -9 -10 -11 -12 -13 18-1 -3 -4 -5 -6 -7 -8 -9 -10 -11 -12 -13 -14 18-15 -16	P S	Amphenol Aerospace  00101406.AA/07-17-14
---------	--------	---	--------	------	--------	---	--------	--



PREVIOUS GOVERNMENT DESIGNATION AND NON-GOVERNMENT STANDARDS BODIES DESIGNATION	MANUFACTURER'S DESIGNATION	MANUFACTURER'S NAME AND QUALIFICATION TEST REFERENCE
-20	-20	Amphenol Aerospace (continued)
-22	-22	
-29	-29	
20-2	20-2	00101406.AA/07-17-14
-3	-3	
-4	-4	
-6	-6	
-7	-7	
-8	-8	
-9	-9	
-11	-11	
-12	-12	
-14	-14	
-15	-15	
-16	-16	
-17	-17	
-18	-18	
-19	-19	
-20	-20	
-21	-21	
-22	-22	
-23	-23	
-24	-24	
-27	-27	
-29	-29	
-33	-33	
22-1	22-1	
-2	-2	
-4	-4	
-5	-5	
-6	-6	
-7	-7	
-8	-8	
-9	-9	
-10	-10	
-11	-11	
-12	-12	
-13	-13	
22-14	22-14	
-15	-15	
-16	-16	
-17	-17	
-18	-18	
-19	-19	
-20	-20	

PREVIOUS GOVERNMENT DESIGNATION AND NON-GOVERNMENT STANDARDS BODIES DESIGNATION	MANUFACTURER'S DESIGNATION	MANUFACTURER'S NAME AND QUALIFICATION TEST REFERENCE
-21	-21	Amphenol Aerospace (continued)
-22	-22	
-23	-23	00101406.AA/07-17-14
-24	-24	
-27	-27	
-28	-28	
-33	-33	
-34	-34	
-36	-36	
24-2	24-2	
-3	-3	
-5	-5	
-6	-6	
-7	-7	
-9	-9	
-10	-10	
-11	-11	
-12	-12	
-16	-16	
-17	-17	
-20	-20	
-21	-21	
-22	-22	
-27	-27	
-28	-28	
28-1	28-1	
-2	-2	
-3	-3	
-4	-4	
-5	-5	
-6	-6	
-8	-8	
-9	-9	
-10	-10	
28-11	28-11	
-12	-12	
-15	-15	
-16	-16	
-17	-17	
-18	-18	
-19	-19	
-20	-20	
-21	-21	
-22	-22	
32-1	32-1	

PREVIOUS GOVERNMENT DESIGNATION AND NON-GOVERNMENT STANDARDS BODIES DESIGNATION	MANUFACTURER'S DESIGNATION	MANUFACTURER'S NAME AND QUALIFICATION TEST REFERENCE
-2	-2	Amphenol Aerospace (continued)  00101406.AA/07-17-14
-3	-3	
-4	-4	
-5	-5	
-6	-6	
-7	-7	
-8	-8	
-9	-9	
-10	-10	
-12	-12	
-13	-13	
-15	-15	
-17	-17	
36-1	36-1	
-3	-3	
-4	-4	
-5	-5	
-6	-6	
-7	-7	
-8	-8	
-9	-9	
-10	-10	
-13	-13	
-14	-14	
-15	-15	
-52	-52	
40-1	40-1	
-9	-9	
-10	-10	
-56	-56	

PREVIOUS GOVERNMENT DESIGNATION AND NON-GOVERNMENT STANDARDS BODIES DESIGNATION	MANUFACTURER'S DESIGNATION	MANUFACTURER'S NAME AND QUALIFICATION TEST REFERENCE
---	-------------------------------	---

**SAE-AS50151 SERIES I - CONNECTORS, SOLDER CONTACT (continued)**

MS25183	8S-1	P	CA3106ER	8S-1	P	ITT Cannon
	10S-2	S		10S-2	S	
	10SL-3			10SL-3		00112906.AJ/07-17-14
	-4			-4		
	12-5			12-5		
	12S-3			12S-3		
	14-3			14-3		
	14S-1			14S-1		
	-2			-2		
	-5			-5		
	-6			-6		
	-7			-7		
	-9			-9		
	16-9			16-9		
	-10			-10		
	-11			-11		
	-12			-12		
	-13			-13		
	16S-1			16S-1		
	-4			-4		
	-5			-5		
	-6			-6		
	-8			-8		
	18-1			18-1		
	-3			-3		
	-4			-4		
	-5			-5		
	-7			-7		
	-8			-8		
	-9			-9		
	-10			-10		
	-11			-11		
	-12			-12		
	-13			-13		
	-15			-15		
	-22			-22		
	20-2			20-2		
	-3			-3		
	-4			-4		
	-7			-7		
	-8			-8		

PREVIOUS GOVERNMENT DESIGNATION AND NON-GOVERNMENT STANDARDS BODIES DESIGNATION	MANUFACTURER'S DESIGNATION	MANUFACTURER'S NAME AND QUALIFICATION TEST REFERENCE
20-11	20-11	ITT Cannon (continued)  00112906.AJ/07-17-14
-14	-14	
-15	-15	
-16	-16	
-17	-17	
-18	-18	
-19	-19	
-22	-22	
-23	-23	
-24	-24	
-27	-27	
-29	-29	
-33	-33	
22-2	22-2	
-4	-4	
-5	-5	
-6	-6	
-7	-7	
-8	-8	
-9	-9	
-10	-10	
-11	-11	
-12	-12	
-13	-13	
-14	-14	
-15	-15	
-17	-17	
-18	-18	
-19	22-19	
-20	-20	
-22	-22	
-23	-23	
-27	-27	
-28	-28	
-31	-31	
24-2	24-2	
-5	-5	
-6	-6	
-7	-7	
-9	-9	
-10	-10	
24-11	24-11	
-12	-12	
-20	-20	
-22	-22	

PREVIOUS GOVERNMENT DESIGNATION AND NON-GOVERNMENT STANDARDS BODIES DESIGNATION	MANUFACTURER'S DESIGNATION	MANUFACTURER'S NAME AND QUALIFICATION TEST REFERENCE
-27	-27	ITT Cannon (continued)  00112906.AJ/07-17-14
-28	-28	
28-1	28-1	
-2	-2	
-8	-8	
-9	-9	
-10	-10	
-11	-11	
-12	-12	
-15	-15	
-16	-16	
-17	-17	
-19	-19	
-20	-20	
-21	-21	
-22	-22	
32-1	32-1	
-6	-6	
-7	-7	
-8	-8	
-9	-9	
-15	-15	
-17	-17	
36-4	36-4	
-5	-5	
-6	-6	
-7	-7	
-8	-8	
-9	-9	
-10	-10	
-15	-15	
40-10	40-10	
-56	-56	

PREVIOUS GOVERNMENT DESIGNATION AND NON-GOVERNMENT STANDARDS BODIES DESIGNATION	MANUFACTURER'S DESIGNATION	MANUFACTURER'S NAME AND QUALIFICATION TEST REFERENCE
---	-------------------------------	---

**SAE-AS50151 SERIES I - CONNECTORS, SOLDER CONTACT (continued)**

MS25183	-	10SL-3	P	SCP06	SJ	10SL-3	P	Spacecraft Component Corp  00140306.AA/07-17-14
	A	10SL-4	S		TJ	10SL-4	S	
		12S-3				12S-3		
		14S-1				14S-1		
		14S-2				14S-2		
		14S-5				14S-5		
		14S-6				14S-6		
		14S-7				14S-7		
		14S-9				14S-9		
		16S-1				16S-1		
		16S-4				16S-4		
		16S-5				16S-5		
		16S-6				16S-6		
		16S-8				16S-8		
		16S-7				16S-7		
		16-10				16-10		
		16-11				16-11		
		16-12				16-12		
		18-1				18-1		
		18-3				18-3		
		18-4				18-4		
		18-6				18-6		
		18-7				18-7		
		18-8				18-8		
		18-9				18-9		
		18-10				18-10		
		18-11				18-11		
		18-12				18-12		
		18-19				18-19		
		18-20				18-20		
		18-22				18-22		
		20-2				20-2		
		20-3				20-3		
		20-4				20-4		
		20-6				20-6		
		20-7				20-7		
		20-11				20-11		
		20-15				20-15		
		20-17				20-17		
		20-18				20-18		
		20-19				20-19		

PREVIOUS GOVERNMENT DESIGNATION AND NON-GOVERNMENT STANDARDS BODIES DESIGNATION	MANUFACTURER'S DESIGNATION	MANUFACTURER'S NAME AND QUALIFICATION TEST REFERENCE
20-21	20-21	Spacecraft Component Corp (continued)
20-22	20-22	
20-23	20-23	00140306.AA/07-17-14
20-24	20-24	
20-27	20-27	
20-29	20-29	
20-33	20-33	
22-1	22-1	
22-2	22-2	
22-4	22-4	
22-5	22-5	
22-7	22-7	
22-8	22-8	
22-9	22-9	
22-10	22-10	
22-12	22-12	
22-14	22-14	
22-19	22-19	
22-20	22-20	
22-21	22-21	
22-22	22-22	
22-23	22-23	
22-27	22-27	
22-28	22-28	
22-34	22-34	
24-2	24-2	
24-4	24-4	
24-6	24-6	
24-7	24-7	
24-9	24-9	
24-10	24-10	
24-11	24-11	
24-12	24-12	
24-19	24-19	
24-20	24-20	
24-21	24-21	
24-22	24-22	
24-27	24-27	
24-28	24-28	
28-1	28-1	
28-2	28-2	
28-3	28-3	
28-6	28-6	
28-9	28-9	
28-10	28-10	



PREVIOUS GOVERNMENT DESIGNATION AND NON-GOVERNMENT STANDARDS BODIES DESIGNATION	MANUFACTURER'S DESIGNATION	MANUFACTURER'S NAME AND QUALIFICATION TEST REFERENCE
28-11	28-11	Spacecraft Component Corp (continued)
28-12	28-12	
28-15	28-15	00140306.AA/07-17-14
28-16	28-16	
28-20	28-20	
28-21	28-21	
28-22	28-22	
32-1	32-1	
32-3	32-3	
32-5	32-5	
32-6	32-6	
32-7	32-7	
32-15	32-15	
32-17	32-17	
32-22	32-22	
32-31	32-31	
32-73	32-73	
36-3	36-3	
36-4	36-4	
36-5	36-5	
36-6	36-6	
36-9	36-9	
36-10	36-10	
36-15	36-15	
40-1	40-1	
40-9	40-9	
40-10	40-10	
40-56	40-56	

PREVIOUS GOVERNMENT DESIGNATION AND NON-GOVERNMENT STANDARDS BODIES DESIGNATION	MANUFACTURER'S DESIGNATION	MANUFACTURER'S NAME AND QUALIFICATION TEST REFERENCE
---	-------------------------------	---

**SAE-AS50151 SERIES I - CONNECTORS, SOLDER CONTACT (continued)**

MS25183	- A	8S-1 10S-2 12S-4 12-5 16-9 16-13 18-5 18-13 18-15 20-8 20-14 20-16 22-6 22-11 22-13 22-15 22-17 22-18 28-17 28-19 32-8 32-9 36-7 36-8 36-14 36-52 40-62	P S	SCP06	SJ TJ	8S-1 10S-2 12S-4 12-5 16-9 16-13 18-5 18-13 18-15 20-8 20-14 20-16 22-6 22-11 22-13 22-15 22-17 22-18 28-17 28-19 32-8 32-9 36-7 36-8 36-14 36-52 40-62	P S	Spacecraft Component Corp  00140306.AD/02-01-2019
---------	--------	---	--------	-------	----------	---	--------	---

PREVIOUS GOVERNMENT DESIGNATION AND NON-GOVERNMENT STANDARDS BODIES DESIGNATION	MANUFACTURER'S DESIGNATION	MANUFACTURER'S NAME AND QUALIFICATION TEST REFERENCE
---	-------------------------------	---

**SAE-AS50151 SERIES I - CONNECTORS, SOLDER CONTACT (continued)**

**MS3100 – M3108 PART NUMBER EXAMPLE, OPTIONS, AND DESCRIPTIONS**  
**Reference: latest issues of AS31001, AS31011, AS31021, AS31031, AS31061, AS31081**

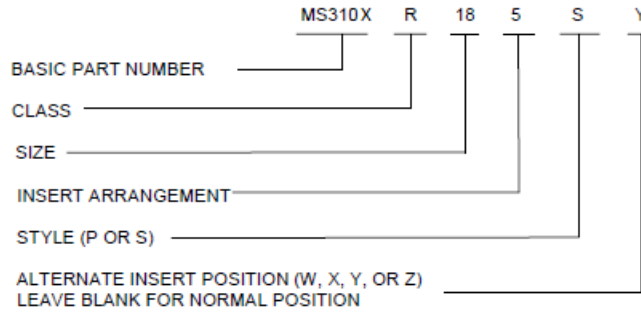

Class 1/: Per latest issues of AS310X1 and AS50151.

Size: Per latest issue of AS50151.

Insert Arrangement: Per latest issue of MIL-STD-1651.

Contact Style 2/:

P = Pin contacts

S = Socket Contacts

Alternate Insert Position 2/: W, X, Y, or Z per latest issue of AS5015. Leave blank for normal position.

1/ Omit for AS31031

2/ All MS310X base part numbers listed in the following matrices are qualified for all variations of Contact Style and Alternate Insert Position.

PREVIOUS GOVERNMENT DESIGNATION AND NON-GOVERNMENT STANDARDS BODIES DESIGNATION				MANUFACTURER'S DESIGNATION		MANUFACTURER'S NAME AND QUALIFICATION TEST REFERENCE		
<b>SAE-AS50151 SERIES I - CONNECTORS, SOLDER CONTACT (continued)</b>								
MS3100	F	8S-1	P	SM3100	F	8S-1	P	Amphenol Aerospace  00101406.AA/07-17-14
MS3101	R	10S-2*	S	SM3101	R	10S-2*	S	
		10SL-3				10SL-3		
MS3102	R	-4**		SM3102	R	-4**		
		12S-3				12S-3		
MS3103	-	-4		SC00	-	-4		* This insert arrangement available for MS3106 only.
		12-5				12-5		
MS3106	F	14S-1		SM3106	F	14S-1		
	R	-2			R	-2		** This insert arrangement available in Style P only for MS3101, MS3102, and MS3103 and Style S only for MS3106.
		-4***				-4***		
		-5				-5		
		-6				-6		
		-7				-7		
		-9				-9		
		14-3				14-3		
		16S-1				16S-1	α	*** This insert arrangement is not available in Class R for MS3100, MS3101, MS3102, and MS3106.
		-3				-3		
		-4				-4		
		-5				-5		
		-6				-6		
		-8				-8		
		16-2				16-2		
		-7				-7		
		-9				-9		**** This insert arrangement is not available in Classes F and R for MS3100, MS3101, MS3102, and MS3106.
		-10				-10		
		-11				-11		
		-12				-12		
		-13				-13		
		18-1				18-1		
		-3				-3		
		-4				-4		
		-5				-5		
		-6				-6		
		-7***				-7***		
		-8				-8		
		-9				-9		
		-10				-10		
		-11				-11		
		-12				-12		
		-13				-13		
		-14***				-14***		

PREVIOUS GOVERNMENT DESIGNATION AND NON-GOVERNMENT STANDARDS BODIES DESIGNATION	MANUFACTURER'S DESIGNATION	MANUFACTURER'S NAME AND QUALIFICATION TEST REFERENCE
18-15	18-15	Amphenol Aerospace (continued)
-16***	-16***	
-20***	-20***	00101406.AA/07-17-14
-22***	-22***	
-29***	-29***	
20-3***	20-3***	
-4	-4	
-6***	-6***	
-7	-7	
-8	-8	
-9	-9	
-11	-11	
-12***	-12***	
-14	-14	
-15	-15	
-16	-16	
-17***	-17***	
-18	-18	
-19	-19	
-20***	-20***	
-21	-21	
-22	-22	
-23	-23	
-24	-24	
-27	-27	
-29	-29	
-33	-33	
22-1	22-1	
-2	-2	
-4	-4	
-5	-5	
-6	-6	
-7	-7	
-8***	-8***	
-9	-9	
-10	-10	
-11	-11	
-12***	-12***	
-13***	-13***	
-14	-14	
-15	-15	
22-16	22-16	
-17***	-17***	
-18	-18	
-19	-19	

PREVIOUS GOVERNMENT DESIGNATION AND NON-GOVERNMENT STANDARDS BODIES DESIGNATION	MANUFACTURER'S DESIGNATION	MANUFACTURER'S NAME AND QUALIFICATION TEST REFERENCE
-20***	-20***	Amphenol Aerospace (continued)
-21***	-21***	
-22	-22	00101406.AA/07-17-14
-23	-23	
-24***	-24***	
-27	-27	
-28***	-28***	
-33***	-33***	
-34	-34	
-36	-36	
24-2	24-2	
-3***	-3***	
-5	-5	
-6***	-6***	
-7	-7	
-9	-9	
-10	-10	
-11	-11	
-12	-12	
-16***	-16***	
-17***	-17***	
-20	-20	
-21	-21	
-22	-22	
-27	-27	
-28	-28	
28-1	28-1	
-2	-2	
-3	-3	
-4***	-4***	
-5***	-5***	
-6***	-6***	
-8***	-8***	
-9	-9	
-10	-10	
-11	-11	
-12	-12	
28-15	28-15	
-16	-16	
-17	-17	
-18	-18	
-19	-19	
-20***	-20***	
-21	-21	
-22***	-22***	

PREVIOUS GOVERNMENT DESIGNATION AND NON-GOVERNMENT STANDARDS BODIES DESIGNATION	MANUFACTURER'S DESIGNATION	MANUFACTURER'S NAME AND QUALIFICATION TEST REFERENCE
32-1 -2 -3 -4**** -5 -6 -7 -8 -9*** -10*** -12*** -13 -15*** -17 36-1*** -3*** -4*** -5 -6 -7 -8 -9 -10 -13**** -14*** -15 -52*** 40-1 -9 -10*** -56 -62	32-1 -2 -3 -4**** -5 -6 -7 -8 -9*** -10*** -12*** -13 -15*** -17 36-1*** -3*** -4*** -5 -6 -7 -8 -9 -10 -13**** -14*** -15 -52*** 40-1 -9 -10*** -56 -62	Amphenol Aerospace (continued) 00101406.AA/07-17-14

PREVIOUS GOVERNMENT DESIGNATION AND NON-GOVERNMENT STANDARDS BODIES DESIGNATION	MANUFACTURER'S DESIGNATION	MANUFACTURER'S NAME AND QUALIFICATION TEST REFERENCE
---	-------------------------------	---

**SAE-AS50151 SERIES I - CONNECTORS, SOLDER CONTACT (continued)**

MS3100	A	44-1	P	CA3100	A	44-1	P	ITT Cannon  00112906.AJ/07-17-14
MS3101			S	CA3101			S	
MS3102				CA3102				

MS3100	R	8S-1	P	CA3100	R	8S-1	P	ITT Cannon
MS3101		10S-2	S	CA3101		10S-2	S	
MS3102		10SL-3		CA3102		10SL-3		00112906.AJ/07-17-14
MS3106		-4		CA3106		-4		
MS3108		12-5		CA3108		12-5		
		12S-3				12S-3		
MS3103	-	-4		CA3103	ER	-4		
		14-3				14-3		
MS3100	F	14S-1		CA3100	E	14S-1		
MS3101		-2		CA3101		-2		
		-5				-5		
MS3106	F	-6		CA3106	R	-6		
		-7				-7		
		-9				-9		
		-14				-14		
		16-9				16-9		
		-10				-10		
		-11				-11		
		-12				-12		
		-13				-13		
		16S-1				16S-1		
		-4				-4		
		-5				-5		
		-6				-6		
		-8				-8		
		18-1				18-1		
		-3				-3		
		-4				-4		
		-5				-5		
		-6				-6		
		-7				-7		
		-8				-8		
		-9				-9		
		-10				-10		
		-11				-11		



PREVIOUS GOVERNMENT DESIGNATION AND NON-GOVERNMENT STANDARDS BODIES DESIGNATION	MANUFACTURER'S DESIGNATION	MANUFACTURER'S NAME AND QUALIFICATION TEST REFERENCE
-12	-12	ITT Cannon (continued)
-13	-13	
18-15	18-15	00112906.AJ/07-17-14
-22	-22	
20-2	20-2	
-3	-3	
-4	-4	
-7	-7	
-8	-8	
-11	-11	
-14	-14	
-15	-15	
-16	-16	
-17	-17	
-18	-18	
-19	-19	
-22	-22	
-23	-23	
-24	-24	
-27	-27	
-29	-29	
-33	-33	
22-2	22-2	
-4	-4	
-5	-5	
-6	-6	
-7	-7	
-8	-8	
-9	-9	
-10	-10	
-11	-11	
-12	-12	
-13	-13	
-14	-14	
-15	-15	
-17	-17	
-18	-18	
-19	-19	
-20	-20	
-22	-22	
-23	-23	
-27	-27	
-28	-28	
24-2	24-2	
-5	-5	

PREVIOUS GOVERNMENT DESIGNATION AND NON-GOVERNMENT STANDARDS BODIES DESIGNATION	MANUFACTURER'S DESIGNATION	MANUFACTURER'S NAME AND QUALIFICATION TEST REFERENCE
-6	-6	ITT Cannon (continued)
-7	-7	
-9	-9	00112906.AJ/07-17-14
-10	-10	
-11	-11	
-12	-12	
-20	-20	
-22	-22	
-27	-27	
-28	-28	
28-1	28-1	
-2	-2	
-9	-9	
-10	-10	
-11	-11	
-12	-12	
-15	-15	
-16	-16	
-17	-17	
-19	-19	
-20	-20	
-21	-21	
-22	-22	
32-1	32-1	
-6	-6	
-7	-7	
-8	-8	
-9	-9	
-15	-15	
-17	-17	
36-4	36-4	
-5	-5	
-6	-6	
-7	-7	
-8	-8	
-9	-9	
-10	-10	
-14	-14	
36-15	36-15	
40-10	40-10	
-56	-56	

PREVIOUS GOVERNMENT DESIGNATION AND NON-GOVERNMENT STANDARDS BODIES DESIGNATION	MANUFACTURER'S DESIGNATION	MANUFACTURER'S NAME AND QUALIFICATION TEST REFERENCE
---	-------------------------------	---

**SAE-AS50151 SERIES I - CONNECTORS, SOLDER CONTACT (continued)**

MS3100	K	8S-1	P	CA3100	K	8S-1	P	ITT Cannon
MS3101		10S-2	S	CA3101		10S-2	S	
MS3102		10SL-3		CA3102		10SL-3		00112906.AJ/07-17-14
MS3106		-4		CA3106		-4		
MS3108		12-5		CA3108		12-5		
		12S-3				12S-3		* This insert arrangement available in Style S only.
		-4				-4		
		14S-1				14S-1		
		-2				-2		
		-4				-4		
		-5				-5		
		-7				-7		
		-9				-9		
		16-7				16-7		
		-9				-9		
		-10				-10		
		-11				-11		
		-12				-12		
		-13				-13		
		16S-1				16S-1		
		-3				-3		
		-4				-4		
		-5				-5		
		-6				-6		
		-8				-8		
		18-1				18-1		
		-3				-3		
		-4				-4		
		-5				-5		
		-7				-7		
		-8				-8		
		-10				-10		
		-11				-11		
		-12				-12		
		-15				-15		
		-20				-20		
		18-22				18-22		
		20-2				20-2		
		-3				-3		
		-4				-4		
		-7				-7		

PREVIOUS GOVERNMENT DESIGNATION AND NON-GOVERNMENT STANDARDS BODIES DESIGNATION	MANUFACTURER'S DESIGNATION	MANUFACTURER'S NAME AND QUALIFICATION TEST REFERENCE
-15	-15	ITT Cannon (continued)
22-2	22-2	
-4	-4	00112906.AJ/07-17-14
-5	-5	
-10	-10	
-11	-11	
-18	-18	
-19	-19	
-21	-21	
-22	-22	
-23	-23	
-27	-27	
-28	-28	
-36*	-36*	
24-1	24-1	
-2	-2	
-3	-3	
-4	-4	
-5	-5	
-6	-6	
-7	-7	
-9	-9	
-12	-12	
-20	-20	
-22	-22	
-27	-27	
-28	-28	
28-2	28-2	
-5	-5	
-9	-9	
-10	-10	
-11	-11	
-12	-12	
-16	-16	
-17	-17	
-20	-20	
28-21	28-21	
-22	-22	
32-1	32-1	
-6	-6	
-7	-7	
-8	-8	
-9	-9	
-13	-13	
-15	-15	

PREVIOUS GOVERNMENT DESIGNATION AND NON-GOVERNMENT STANDARDS BODIES DESIGNATION	MANUFACTURER'S DESIGNATION	MANUFACTURER'S NAME AND QUALIFICATION TEST REFERENCE										
<table border="1"> <tr><td>-17</td></tr> <tr><td>36-1</td></tr> <tr><td>-3</td></tr> <tr><td>-8</td></tr> <tr><td>-10</td></tr> </table>	-17	36-1	-3	-8	-10	<table border="1"> <tr><td>-17</td></tr> <tr><td>36-1</td></tr> <tr><td>-3</td></tr> <tr><td>-8</td></tr> <tr><td>-10</td></tr> </table>	-17	36-1	-3	-8	-10	ITT Cannon (continued)  00112906.AJ/07-17-14
-17												
36-1												
-3												
-8												
-10												
-17												
36-1												
-3												
-8												
-10												

PREVIOUS GOVERNMENT DESIGNATION AND NON-GOVERNMENT STANDARDS BODIES DESIGNATION	MANUFACTURER'S DESIGNATION	MANUFACTURER'S NAME AND QUALIFICATION TEST REFERENCE
---	-------------------------------	---

**SAE-AS50151 SERIES I - CONNECTORS, SOLDER CONTACT (continued)**

MS3100	R	10SL-3	P	SCP00	RJ	10SL-3	P	Spacecraft Component Corp
MS3101		10SL-4	S	SCP01		10SL-4	S	
MS3102		12S-3		SCP02		12S-3		00140306.AD/07-17-14
MS3106		14S-1		SCP06		14S-1		
MS3108		14S-2		SCP08		14S-2		
		14S-5				14S-5		
MS3103	-	14S-6		SCP03	-	14S-6		
		14S-7				14S-7		
MS3100	F	14S-9		SCP00	EJ	14S-9		
MS3101		16S-1		SCP01		16S-1		
MS3106		16S-4		SCP06		16S-4		
		16S-5				16S-5		
		16S-6				16S-6		
		16S-8				16S-8		
		16S-7				16S-7		
		16-10				16-10		
		16-11				16-11		
		16-12				16-12		
		18-1				18-1		
		18-3				18-3		
		18-4				18-4		
		18-6				18-6		
		18-7				18-7		
		18-8				18-8		
		18-9				18-9		
		18-10				18-10		
		18-11				18-11		
		18-12				18-12		
		18-19				18-19		
		18-20				18-20		
		18-22				18-22		
		20-2				20-2		
		20-3				20-3		
		20-4				20-4		
		20-6				20-6		
		20-7				20-7		
		20-11				20-11		
		20-15				20-15		
		20-17				20-17		
		20-18				20-18		
		20-19				20-19		

PREVIOUS GOVERNMENT DESIGNATION AND NON-GOVERNMENT STANDARDS BODIES DESIGNATION	MANUFACTURER'S DESIGNATION	MANUFACTURER'S NAME AND QUALIFICATION TEST REFERENCE
20-21	20-21	Spacecraft Component Corp (continued)
20-22	20-22	
20-23	20-23	00140306.AD/07-17-14
20-24	20-24	
20-27	20-27	
20-29	20-29	
20-33	20-33	
22-1	22-1	
22-2	22-2	
22-4	22-4	
22-5	22-5	
22-7	22-7	
22-8	22-8	
22-9	22-9	
22-10	22-10	
22-12	22-12	
22-14	22-14	
22-19	22-19	
22-20	22-20	
22-21	22-21	
22-22	22-22	
22-23	22-23	
22-27	22-27	
22-28	22-28	
22-34	22-34	
24-2	24-2	
24-4	24-4	
24-6	24-6	
24-7	24-7	
24-9	24-9	
24-10	24-10	
24-11	24-11	
24-12	24-12	
24-19	24-19	
24-20	24-20	
24-21	24-21	
24-22	24-22	
24-27	24-27	
24-28	24-28	
28-1	28-1	
28-2	28-2	
28-3	28-3	
28-6	28-6	
28-9	28-9	
28-10	28-10	

PREVIOUS GOVERNMENT DESIGNATION AND NON-GOVERNMENT STANDARDS BODIES DESIGNATION	MANUFACTURER'S DESIGNATION	MANUFACTURER'S NAME AND QUALIFICATION TEST REFERENCE
28-11	28-11	Spacecraft Component Corp (continued)
28-12	28-12	
28-15	28-15	00140306.AD/07-17-14
28-16	28-16	
28-20	28-20	
28-21	28-21	
28-22	28-22	
32-1	32-1	
32-3	32-3	
32-5	32-5	
32-6	32-6	
32-7	32-7	
32-15	32-15	
32-17	32-17	
32-22	32-22	
32-31	32-31	
32-73	32-73	
36-3	36-3	
36-4	36-4	
36-5	36-5	
36-6	36-6	
36-9	36-9	
36-10	36-10	
36-15	36-15	
40-1	40-1	
40-9	40-9	
40-10	40-10	
40-56	40-56	



PREVIOUS GOVERNMENT DESIGNATION AND NON-GOVERNMENT STANDARDS BODIES DESIGNATION		MANUFACTURER'S DESIGNATION		MANUFACTURER'S NAME AND QUALIFICATION TEST REFERENCE				
<b>SAE-AS50151 SERIES I - CONNECTORS, SOLDER CONTACT (continued)</b>								
MS3100	R	8S-1	P	SCP00	RJ	8S-1	P	Spacecraft Component Corp 00140306.AD/2-01-2019
MS3101		10S-2	S	SCP01		10S-2	S	
MS3102		12S-4		SCP02		12S-4		
MS3106		12-5		SCP06		12-5		
MS3108		16-9		SCP08		16-9		
		16-13				16-13		
MS3103	-	18-5		SCP03	-	18-5		
		18-13				18-13		
MS3100	F	18-15		SCP00	EJ	18-15		
MS3101		20-8		SCP01		20-8		
MS3106		20-14		SCP06		20-14		
		20-16				20-16		
		22-6				22-6		
		22-11				22-11		
		22-13				22-13		
		22-15				22-15		
		22-17				22-17		
		22-18				22-18		
		28-17				28-17		
		28-19				28-19		
		32-8				32-8		
		32-9				32-9		
		36-7				36-7		
		36-8				36-8		
		36-14				36-14		
		36-52				36-52		
		40-62				40-62		

PREVIOUS GOVERNMENT DESIGNATION AND NON-GOVERNMENT STANDARDS BODIES DESIGNATION	MANUFACTURER'S DESIGNATION	MANUFACTURER'S NAME AND QUALIFICATION TEST REFERENCE
---	----------------------------	--

**SAE-AS50151 SERIES I - CONNECTORS, SOLDER CONTACT (continued)**

**MS3436 PART NUMBER EXAMPLE, OPTIONS, AND DESCRIPTIONS**

**Reference: latest issue of AS34361**

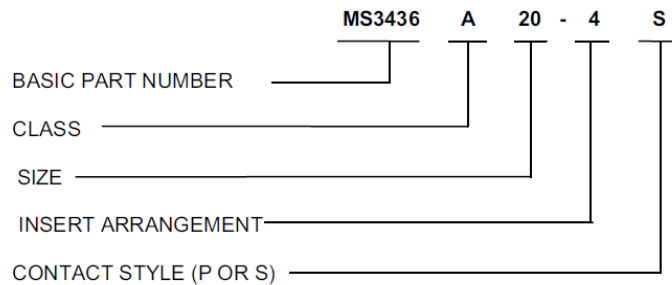

Class: Per latest issues of AS34361 and AS50151.

Shell Size: Per latest issue of AS50151.

Insert Arrangement: Per latest issue of MIL-STD-1651.

Contact Style 1/:

P = Pin contacts

S = Socket Contacts

1/ All MS3436 base part numbers listed in the following matrices are qualified for all variations of Contact Style and Alternate Insert Position.

MS3436   A   20-4   P S	CA3436   A   20-4   P S	ITT Cannon 00112906.AJ/07-17-14
----------------------------	----------------------------	------------------------------------

MS3436   A   20-4   P S	SCP3436   A   20-4   P S	Spacecraft Component Corp 00140306.AC/07-09-19
----------------------------	-----------------------------	---

PREVIOUS GOVERNMENT DESIGNATION AND NON-GOVERNMENT STANDARDS BODIES DESIGNATION	MANUFACTURER'S DESIGNATION	MANUFACTURER'S NAME AND QUALIFICATION TEST REFERENCE
---	----------------------------	--

**SAE-AS50151 SERIES I - CONNECTORS, SOLDER CONTACT (continued)**

**MS3507 PART NUMBER EXAMPLE, OPTIONS, AND DESCRIPTIONS**

**Reference: latest issue of AS35071**

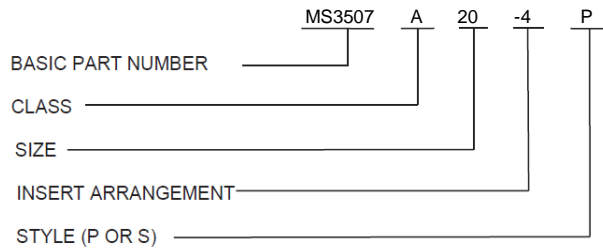

Class: Per latest issues of AS35071 and AS50151.

Shell Size: Per latest issue of AS50151.

Insert Arrangement: Per latest issue of MIL-STD-1651.

Contact Style 1/:

P = Pin contacts

S = Socket Contacts

1/ All MS3507 base part numbers listed in the following matrices are qualified for all variations of Contact Style and Alternate Insert Position.

MS3507 | A | 20-4 | P

CA3507 | A | 20-4 | P

ITT Cannon

00112906.AJ/07-17-14

MS3507 | A | 20-4 | P

SCP3507 | A | 20-4 | P

Spacecraft Component Corp

00140306.AC/07-09-19

PREVIOUS GOVERNMENT DESIGNATION AND NON-GOVERNMENT STANDARDS BODIES DESIGNATION	MANUFACTURER'S DESIGNATION	MANUFACTURER'S NAME AND QUALIFICATION TEST REFERENCE
---	-------------------------------	---

**SAE-AS50151 SERIES II - CONNECTORS, CRIMP CONTACT, FRONT RELEASE**

**MS3400, MS3401, MS3402, MS3404, MS3406, MS3408, MS3409, MS3412**  
**PART NUMBER EXAMPLE, OPTIONS, AND DESCRIPTIONS**

Reference: latest issues of  
**AS34001, AS34011, AS34021, AS34041, AS34061, AS34081, AS34091, AS34121**

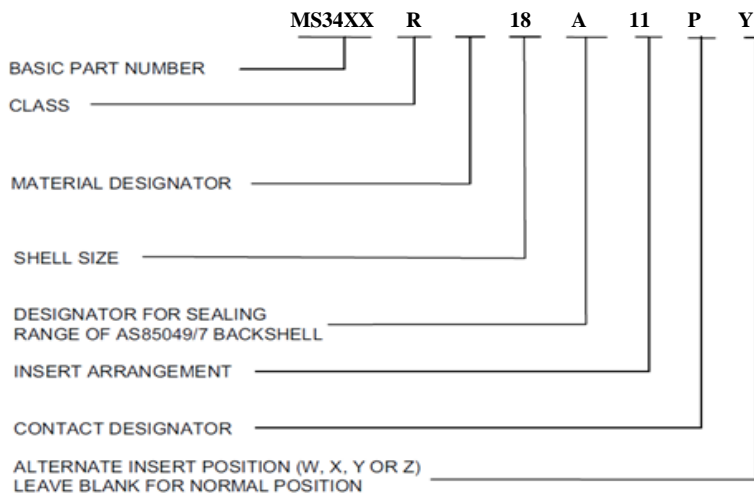

Class: Per latest issues of AS34XX1 and AS50151.

Material Designator 1/: Per latest issue of AS34XX1.

Shell Size: Per latest issue of AS50151.

Designator for Sealing Range of AS85049/7 Backshell 2/, 3/: Per latest issue of AS34XX1.

Insert Arrangement: Per latest issue of MIL-STD-1651.

Contact Style 4/:

P = Pin contacts

S = Socket Contacts

Alternate Insert Position 4/: W, X, Y, or Z per latest issue of AS5015. Leave blank for normal position.

1/: Omit for MS3408 and MS3409 Class D

2/: Omit for MS3408

3/: Omit for MS3401, MS3402, MS3404, MS3408, MS3409, MS34121 and insert “ – ”

4/ All MS34XX base part numbers listed in the following matrices are qualified for all variations of Contact Style and Alternate Insert Position.

PREVIOUS GOVERNMENT DESIGNATION AND NON-GOVERNMENT STANDARDS BODIES DESIGNATION			MANUFACTURER'S DESIGNATION				MANUFACTURER'S NAME AND QUALIFICATION TEST REFERENCE
<b>SAE-AS50151 SERIES II - CONNECTORS, CRIMP CONTACT, FRONT RELEASE</b>							
<b>(continued)</b>							

MS3400	D	8S-1	P	CJ1100	D	8S-1	P	Corsair Electrical
MS3401	DJ	10S-2	S	CJ1101	DJ	10S-2	S	
MS3402	DJS	10SL-3	D	CJ1102	DJS	10SL-3	D	00140708.AE/07-17-14
MS3404	DS	10SL-4	E	CJ1104	DS	10SL-4	E	
MS3406	L	12-5		CJ1106	L	12-5		
MS3408	LS	12S-3		CJ1108	LS	12S-3		
MS3409	W	14-3		CJ1109	W	14-3		
MS3412		14S-2		CJ1112		14S-2		
		14S-5				14S-5		
		14S-6				14S-6		
		14S-7				14S-7		
		14S-9				14S-9		
		16-9				16-9		
		16-10				16-10		
		16-11				16-11		
		16-13				16-13		
		16S-1*				16S-1*		
		16S-4				16S-4		
		16S-5				16S-5		
		16S-6				16S-6		
		16S-8				16S-8		
		18-1				18-1		
		18-3				18-3		
		18-4				18-4		
		18-5				18-5		
		18-6				18-6		
		18-8				18-8		
		18-9				18-9		
		18-10				18-10		
		18-11				18-11		
		18-12				18-12		
		18-15				18-15		
		18-16				18-16		
		18-19				18-19		
		18-20				18-20		
		18-22				18-22		
		20-2				20-2		
		20-3				20-3		
		20-4				20-4		
		20-6				20-6		
		20-7				20-7		

PREVIOUS GOVERNMENT DESIGNATION AND NON-GOVERNMENT STANDARDS BODIES DESIGNATION	MANUFACTURER'S DESIGNATION	MANUFACTURER'S NAME AND QUALIFICATION TEST REFERENCE
20-8	20-8	Corsair Electrical
20-11	20-11	
20-15	20-15	00140708.AE/07-17-14
20-16	20-16	
20-17	20-17	
20-18	20-18	
20-19	20-19	
20-21	20-21	
20-22*	20-22*	
20-23	20-23	
20-27	20-27	
20-29	20-29	
20-33	20-33	
22-2	22-2	
22-5	22-5	
22-9	22-9	
22-10	22-10	
22-11	22-11	
22-12	22-12	
22-13	22-13	
22-14	22-14	
22-18	22-18	
22-19	22-19	
22-21	22-21	
22-22	22-22	
22-23	22-23	
22-27	22-27	
24-28	24-28	
22-33	22-33	
24-2	24-2	
24-5	24-5	
24-6	24-6	
24-7*	24-7*	
24-9	24-9	
24-10	24-10	
24-11	24-11	
24-12	24-12	
24-18	24-18	
24-21	24-21	
24-22	24-22	
24-24	24-24	
24-27*	24-27*	
24-28	24-28	
24-80	24-80	
28-1	28-1	

PREVIOUS GOVERNMENT DESIGNATION AND NON-GOVERNMENT STANDARDS BODIES DESIGNATION	MANUFACTURER'S DESIGNATION	MANUFACTURER'S NAME AND QUALIFICATION TEST REFERENCE
28-2	28-2	Corsair Electrical (continued)
28-3	28-3	
28-5	28-5	00140708.AE/07-17-14
28-6	28-6	
28-8	28-8	
28-9	28-9	
28-10	28-10	
28-11	28-11	
28-12	28-12	
28-15	28-15	
28-16	28-16	
28-17	28-17	
28-18	28-18	
28-20	28-20	
28-21	28-21	
28-22	28-22	
32-1	32-1	
32-3*	32-3*	
32-5	32-5	
32-6	32-6	
32-7	32-7	
32-8	32-8	
32-13	32-13	
32-15	32-15	
32-17	32-17	
32-22	32-22	
32-73	32-73	
36-3	36-3	
36-5	36-5	
36-6	36-6	
36-7	36-7	
36-8	36-8	
36-9	36-9	
36-10	36-10	
36-15	36-15	
36-8	36-8	
36-9	36-9	
36-10	36-10	
36-15	36-15	
36-52	36-52	
36-66	36-66	
40-5	40-5	
40-9	40-9	
40-10	40-10	
40-56	40-56	

PREVIOUS GOVERNMENT DESIGNATION AND NON-GOVERNMENT STANDARDS BODIES DESIGNATION	MANUFACTURER'S DESIGNATION	MANUFACTURER'S NAME AND QUALIFICATION TEST REFERENCE						
<table border="1"> <tr><td>40-62</td></tr> <tr><td>44-52</td></tr> <tr><td>48-62</td></tr> </table>	40-62	44-52	48-62	<table border="1"> <tr><td>40-62</td></tr> <tr><td>44-52</td></tr> <tr><td>48-62</td></tr> </table>	40-62	44-52	48-62	Corsair Electrical (continued)  00140708.AE/07-17-14
40-62								
44-52								
48-62								
40-62								
44-52								
48-62								



PREVIOUS GOVERNMENT DESIGNATION AND NON-GOVERNMENT STANDARDS BODIES DESIGNATION	MANUFACTURER'S DESIGNATION	MANUFACTURER'S NAME AND QUALIFICATION TEST REFERENCE
---	-------------------------------	---

**SAE-AS50151 SERIES II - CONNECTORS, CRIMP CONTACT, FRONT RELEASE  
(continued)**

MS3400	D	10SL-3	P	M3400	D	10SL-3	P	ElecSys, Inc.
MS3400	DJ	-4	S	T3400	DJ	-4	S	
MS3401	DS	12-5	D*	M3401	DS	12-5	D*	00125606.AG/07-17-14
MS3401	DJS	12S-3	E*	T3401	DJS	12S-3	E*	
MS3406	L	14S-2		M3406	L	14S-2		* D and E only apply to Classes D and L.
MS3406	W	-5		T3406	W	-5		
	U	-6			U	-6		
		-7				-7		
MS3402	D	-9		M3402	D	-9		
MS3402	DS	16-10		T3402	DS	16-10		
MS3404	L	-11		M3404	L	-11		
MS3404	W	-13		T3404	W	-13		
MS3412	U	16S-1		M3412	U	16S-1		
MS3412		-4		T3412		-4		
		-6				-6		
MS3408	D	-8		M3408	D	-8		
MS3408	DS	18-1		T3408	DS	18-1		
	DJ	-3			DJ	-3		
	DJS	-4			DJS	-4		
	L	-8			L	-8		
		-9				-9		
MS3409	D	-10		M3409	D	-10		
MS3409	DS	-11		T3409	DS	-11		
	DJ	-12			DJ	-12		
	DJS	-13			DJS	-13		
		-15				-15		
		-22				-22		
		20-2				20-2		
		-4				-4		
		-7				-7		
		-8				-8		
		-15				-15		
		-16				-16		
		-17				-17		
		-18				-18		
		-19				-19		
		-27				-27		
		-29				-29		
		-33				-33		
		22-2				22-2		
		-5				-5		

PREVIOUS GOVERNMENT DESIGNATION AND NON-GOVERNMENT STANDARDS BODIES DESIGNATION	MANUFACTURER'S DESIGNATION	MANUFACTURER'S NAME AND QUALIFICATION TEST REFERENCE
-10	-10	ElecSys, Inc. (continued)  00125606.AG/07-17-14
-11	-11	
-14	-14	
-15	-15	
-18	-18	
-19	-19	
-21	-21	
-22	-22	
-23	-23	
24-6	24-6	
-7	-7	
-10	-10	
-11	-11	
-12	-12	
-21	-21	
-22	-22	
-27	-27	
-28	-28	
28-2	28-2	
-3	-3	
-9	-9	
-11	-11	
-12	-12	
-15	-15	
-16	-16	
-18	-18	
-20	-20	
-21	-21	
-22	-22	
32-1	32-1	
-6	-6	
-7	-7	
-13	-13	
-17	-17	
-22	-22	
-73	-73	
36-3	36-3	
-5	-5	
-6	-6	
36-7	36-7	
-8	-8	
-9	-9	
-10	-10	
-15	-15	
-52	-52	

PREVIOUS GOVERNMENT DESIGNATION AND NON-GOVERNMENT STANDARDS BODIES DESIGNATION	MANUFACTURER'S DESIGNATION	MANUFACTURER'S NAME AND QUALIFICATION TEST REFERENCE
-66 40-5 -9 -10 -56 -62 44-52 48-62	-66 40-5 -9 -10 -56 -62 44-52 48-62	ElecSys, Inc. (continued)  00125606.AG/07-17-14

PREVIOUS GOVERNMENT DESIGNATION AND NON-GOVERNMENT STANDARDS BODIES DESIGNATION				MANUFACTURER'S DESIGNATION	MANUFACTURER'S NAME AND QUALIFICATION TEST REFERENCE			
<b>SAE-AS50151 SERIES II - CONNECTORS, CRIMP CONTACT, FRONT RELEASE</b>								
<b>(continued)</b>								
MS3401	D	8S-1	A	JT3401	D	8S-1	A	J-Tech, Inc.
	DJ	10S-2	B		DJ	10S-2	B	
	DS	10SL-3	P		DS	10SL-3	P	00113406.AD/07-17-14
	DJS	-4	S		DJS	-4	S	
	W	12S-3	D*		W	12S-3	D*	
	L	14-3	E*		L	14-3	E*	* D & E only apply to classes D & L.
	U	14S-2			U	14S-2		
		-5				-5		
MS3408	D	-6		JT3408	D	-6		
	DJ	-7			DJ	-7		
	DS	-9			DS	-9		
	DJS	16S-1			DJS	16S-1		
	L	-4			L	-4		
		-5				-5		
		-6				-6		
MS3402	D	16S-8		JT3402	D	16S-8		
MS3404	DS	16-9		JT3404	DS	16-9		
MS3412	W	-10		JT3412	W	-10		
	L	-11			L	-11		
	U	18-1			U	18-1		
		-3				-3		
MS3409	D	18-4		JT3409	D	18-4		
	DJ	-5			DJ	-5		
	DS	-6			DS	-6		
	DJS	-8			DJS	-8		
		-9				-9		
MS3400	D	-10		JT3400	D	-10		
MS3406	DJ	-11		JT3406	DJ	-11		
	DS	-12			DS	-12		
	DJS	-20			DJS	-20		
MS3400	W	-22		JT3400	W	-22		
MS3406	L	20-3		JT3406	L	20-3		
	U	-4			U	-4		
	KS	-6			KS	-6		
	KT	-7			KT	-7		
		-8				-8		
		-11				-11		
		-15				-15		
		-17				-17		
		-18				-18		
		-19				-19		

PREVIOUS GOVERNMENT DESIGNATION AND NON-GOVERNMENT STANDARDS BODIES DESIGNATION	MANUFACTURER'S DESIGNATION	MANUFACTURER'S NAME AND QUALIFICATION TEST REFERENCE
-22	-22	J-Tech, Inc.
-23	-23	(continued)
-27	-27	
-29	-29	00113406.AD/07-17-14
-33	-33	
22-2	22-2	
-5	-5	
-9	-9	
-10	-10	
-11	-11	
-12	-12	
-13	-13	
-14	-14	
-15	-15	
-18	-18	
-19	-19	
-21	-21	
-22	-22	
-23	-23	
-27	-27	
-28	-28	
22-33	22-33	
24-2	24-2	
-5	-5	
-6	-6	
-7	-7	
-9	-9	
-10	-10	
-11	-11	
-12	-12	
-22	-22	
-27	-27	
-28	-28	
-80	-80	
28-1	28-1	
-2	-2	
-6	-6	
-8	-8	
-9	-9	
-10	-10	
-11	-11	
-12	-12	
-15	-15	
-16	-16	
-17	-17	

PREVIOUS GOVERNMENT DESIGNATION AND NON-GOVERNMENT STANDARDS BODIES DESIGNATION	MANUFACTURER'S DESIGNATION	MANUFACTURER'S NAME AND QUALIFICATION TEST REFERENCE
-18	-18	J-Tech, Inc.
-20	-20	(continued)
-21	-21	
-22	-22	00113406.AD/07-17-14
32-5	32-5	
-6	-6	
-7	-7	
-8	-8	
-13	-13	
-17	-17	
-22	-22	
-73	-73	
36-5	36-5	
-6	-6	
-7	-7	
-8	-8	
-9	-9	
36-10	36-10	
-15	-15	
-66	-66	
40-1	40-1	
-9	-9	
-10	-10	
-56	-56	
-62	-62	
44-52	44-52	

PREVIOUS GOVERNMENT DESIGNATION AND NON-GOVERNMENT STANDARDS BODIES DESIGNATION	MANUFACTURER'S DESIGNATION	MANUFACTURER'S NAME AND QUALIFICATION TEST REFERENCE
---	-------------------------------	---

**SAE-AS50151 SERIES II - CONNECTORS, CRIMP CONTACT, FRONT RELEASE  
(continued)**

MS3400	D	8S-1	A	SC30	D	8S-1	A	Spacecraft Component Corp
MS3401	DJ	10S-2	B	SC31	DJ	10S-2	B	
MS3402	DT	10SL-3	P	SC32	DT	10SL-3	P	00140306.AC/07-09-19
MS3404	DZ	10SL-4	S	SC34	DZ	12-4	S	
MS3406	L	12-5		SC36	L	12-5		
MS3408	WT	12S-3		SC38	WT	12S-3		
MS3409	WZ	12S-4		SC39	WZ	12S-4		
MS3412		14-3		SC33		14-3		
		14S-1				14S-1		
		-2				-2		
		-4				-4		
		-5				-5		
		-6				-6		
		-7				-7		
		-9				-9		
		16-2				16-2		
		-7				-7		
		-9				-9		
		-10				-10		
		-11				-11		
		-12				-12		
		-13				-13		
		16S-1				16S-1		
		-3				-3		
		-4				-4		
		-5				-5		
		-6				-6		
		-8				-8		
		18-1				18-1		
		-3				-3		
		-4				-4		
		-5				-5		
		-6				-6		
		-7				-7		
		-8				-8		
		-9				-9		
		-10				-10		
		-11				-11		
		-12				-12		
		-13				-13		
		-14				-14		

PREVIOUS GOVERNMENT DESIGNATION AND NON-GOVERNMENT STANDARDS BODIES DESIGNATION	MANUFACTURER'S DESIGNATION	MANUFACTURER'S NAME AND QUALIFICATION TEST REFERENCE
-15	-15	Spacecraft Component Corp (continued)
-16	-16	
-20	-20	00140306.AC/07-09-19
-22	-22	
-29	-29	
20-2	20-2	
-3	-3	
-4	-4	
-5	-5	
-6	-6	
-7	-7	
-8	-8	
-9	-9	
-11	-11	
-12	-12	
-14	-14	
-15	-15	
-16	-16	
-17	-17	
-18	-18	
-19	-19	
-20	-20	
-21	-21	
-22	-22	
-23	-23	
-24	-24	
-27	-27	
-29	-29	
-31	-31	
-33	-33	
22-1	22-1	
-2	-2	
-3	-3	
-4	-4	
-5	-5	
-6	-6	
-7	-7	
-8	-8	
-9	-9	
-10	-10	
-11	-11	
-12	-12	
-13	-13	
-14	-14	
-15	-15	



PREVIOUS GOVERNMENT DESIGNATION AND NON-GOVERNMENT STANDARDS BODIES DESIGNATION	MANUFACTURER'S DESIGNATION	MANUFACTURER'S NAME AND QUALIFICATION TEST REFERENCE
-16	-16	Spacecraft Component Corp (continued)
-17	-17	
-18	-18	00140306.AC/07-09-19
-19	-19	
-20	-20	
-21	-21	
-22	-22	
-23	-23	
-24	-24	
-25	-25	
-27	-27	
-28	-28	
-29	-29	
-33	-33	
-34	-34	
-36	-36	
-63	-63	
24-1	24-1	
-2	-2	
-3	-3	
-4	-4	
-5	-5	
-6	-6	
-7	-7	
-9	-9	
-10	-10	
-11	-11	
-12	-12	
-14	-14	
-16	-16	
-17	-17	
-20	-20	
-21	-21	
-22	-22	
-23	-23	
-27	-27	
-28	-28	
-80	-80	
28-1	28-1	
-2	-2	
-3	-3	
-4	-4	
-5	-5	
-6	-6	
-8	-8	

PREVIOUS GOVERNMENT DESIGNATION AND NON-GOVERNMENT STANDARDS BODIES DESIGNATION	MANUFACTURER'S DESIGNATION	MANUFACTURER'S NAME AND QUALIFICATION TEST REFERENCE	
-9	-9	Spacecraft Component Corp (continued)	
-10	-10		
-11	-11		
-12	-12		
-14	-14		
-15	-15		
-16	-16		
-17	-17		
-18	-18		
-19	-19		
-20	-20		
-21	-21		
-22	-22		
32-1	32-1		00140306.AC/07-09-19
-2	-2		
-3	-3		
-4	-4		
-5	-5		
-6	-6		
-7	-7		
-8	-8		
-9	-9		
-10	-10		
-12	-12		
-13	-13		
-14	-14		
-15	-15		
-17	-17		
-22	-22		
-63	-63		
-73	-73		
36-1	36-1		
-3	-3		
-4	-4		
-5	-5		
-6	-6		
-7	-7		
-8	-8		
-9	-9		
-10	-10		
-13	-13		
-14	-14		
-15	-15		
-19	-19		
-52	-52		

PREVIOUS GOVERNMENT DESIGNATION AND NON-GOVERNMENT STANDARDS BODIES DESIGNATION	MANUFACTURER'S DESIGNATION	MANUFACTURER'S NAME AND QUALIFICATION TEST REFERENCE
-66 40-1 -2 -3 -4 -5 -6 -7 -9 -10 -11 -56 -62	-66 40-1 -2 -3 -4 -5 -6 -7 -9 -10 -11 -56 -62	Spacecraft Component Corp (continued)  00140306.AC/07-09-19

PREVIOUS GOVERNMENT DESIGNATION AND NON-GOVERNMENT STANDARDS BODIES DESIGNATION	MANUFACTURER'S DESIGNATION	MANUFACTURER'S NAME AND QUALIFICATION TEST REFERENCE
---	----------------------------	--

**SAE-AS50151 SERIES III - CONNECTORS, CRIMP CONTACT, REAR RELEASE**

**MS3450, MS3451, MS3452, MS3454, MS3456, MS3459**  
**PART NUMBER EXAMPLE, OPTIONS, AND DESCRIPTIONS**

Reference: latest issues of  
 AS34501, AS34511, AS34521, AS34541, AS34561, AS34591

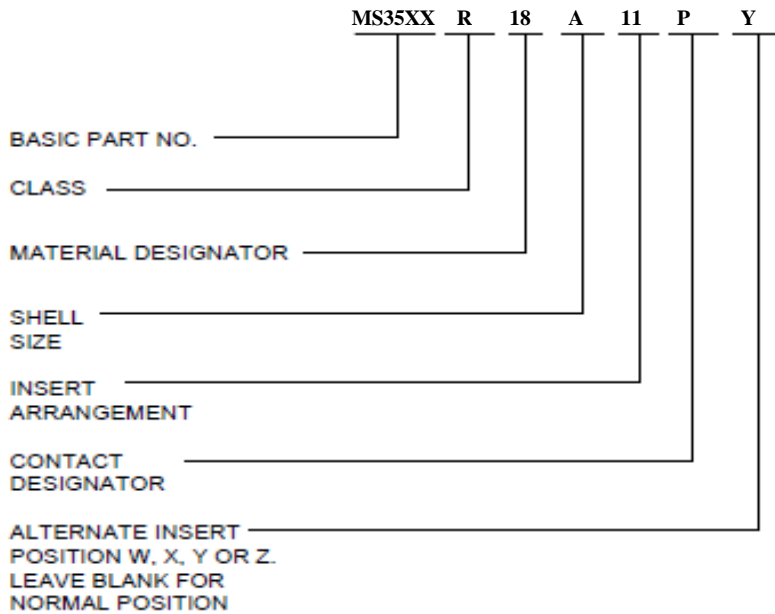

Class: Per latest issues of AS350X1 and AS50151.

Material Designator: Per latest issue of AS350X1.

Shell Size: Per latest issue of AS50151.

Insert Arrangement: Per latest issue of MIL-STD-1651.

Contact Style 1/:  
 P = Pin contacts  
 S = Socket Contacts

Alternate Insert Position 1/: W, X, Y, or Z per latest issue of AS5015. Leave blank for normal position.

1/: All MS350X base part numbers listed in the following matrices are qualified for all variations of Contact Style and Alternate Insert Position.

PREVIOUS GOVERNMENT DESIGNATION AND NON-GOVERNMENT STANDARDS BODIES DESIGNATION	MANUFACTURER'S DESIGNATION	MANUFACTURER'S NAME AND QUALIFICATION TEST REFERENCE
<b>SAE-AS50151 SERIES III - CONNECTORS, CRIMP CONTACT, REAR RELEASE</b>		
<b>(continued)</b>		

MS3450	LS	8S-1	A	AE550	LS	8S-1	A	Aero-Electric Connector
MS3456	L	10S-2	B	AE556	L	10S-2	B	
MS3459	W	10SL-3	P	AE559	W	10SL-3	P	00100606.AC/07-17-14
	KT	-4	S		KT	-4	S	
	KS	12S-3			KS	12S-3		
		-4				-4		
		12-5				12-5		
MS3451	L	14S-1		AE551	L	14S-1		
MS3452	W	-2		AE552	W	-2		
MS3454	LS	-5		AE554	LS	-5		
		-6				-6		
		-7				-7		
		-9				-9		
MS3454	LS	14-3		AE554	LS	14-3		
		16S-1				16S-1		
		-4				-4		
		-5				-5		
		-8				-8		
		16-10				16-10		
		-11				-11		
		-12				-12		
		18-1				18-1		
		-4				-4		
		-5				-5		
		-6				-6		
		-8				-8		
		-9				-9		
		18-10				18-10		
		-11				-11		
		-12				-12		
		-20				-20		
		20-1				20-1		
		-2				-2		
		-3				-3		
		-4				-4		
		-7				-7		
		-8				-8		
		-11				-11		
		-14				-14		
		-15				-15		
		-16				-16		

PREVIOUS GOVERNMENT DESIGNATION AND NON-GOVERNMENT STANDARDS BODIES DESIGNATION	MANUFACTURER'S DESIGNATION	MANUFACTURER'S NAME AND QUALIFICATION TEST REFERENCE
-17	-17	Aero-Electric Connector (continued)
-18	-18	
-22	-22	00100606.AC/07-17-14
-24	-24	
-27	-27	
-29	-29	
-33	-33	
22-1	22-1	
-2	-2	
-9	-9	
-11	-11	
-12	-12	
-13	-13	
-14	-14	
-17	-17	
-18	-18	
-19	-19	
-20	-20	
-21	-21	
-22	-22	
-23	-23	
-27	-27	
-33	-33	
24-2	24-2	
-4	-4	
24-6	24-6	
-7	-7	
-9	-9	
-10	-10	
-11	-11	
-12	-12	
-20	-20	
-21	-21	
-22	-22	
-27	-27	
-28	-28	
28-1	28-1	
-2	-2	
-3	-3	
-5	-5	
-6	-6	
-8	-8	
-9	-9	
-11	-11	
-12	-12	

PREVIOUS GOVERNMENT DESIGNATION AND NON-GOVERNMENT STANDARDS BODIES DESIGNATION	MANUFACTURER'S DESIGNATION	MANUFACTURER'S NAME AND QUALIFICATION TEST REFERENCE
-15	-15	Aero-Electric Connector (continued)  00100606.AC/07-17-14
-16	-16	
-19	-19	
-20	-20	
-21	-21	
-22	-22	
32-1	32-1	
-3	-3	
-5	-5	
-6	-6	
-7	-7	
-8	-8	
-10	-10	
-15	-15	
-17	-17	
-22	-22	
-63	-63	
-73	-73	
36-3	36-3	
-5	-5	
-6	-6	
36-7	36-7	
-8	-8	
-9	-9	
-10	-10	
40-4	40-4	
-10	-10	
-56	-56	

PREVIOUS GOVERNMENT DESIGNATION AND NON-GOVERNMENT STANDARDS BODIES DESIGNATION	MANUFACTURER'S DESIGNATION	MANUFACTURER'S NAME AND QUALIFICATION TEST REFERENCE
---	-------------------------------	---

**SAE-AS50151 SERIES III - CONNECTORS, CRIMP CONTACT, REAR RELEASE  
(continued)**

MS3450	L	8S-1	P	9440	F	8S-1	P	Amphenol Aerospace  00101403.AC/07-17-14  * This insert arrangement available in Style S only.  **This insert arrangement available in Style P only.
MS3456	LS	10S-2	S	9446	FS	10S-2	S	
	U	10SL-3			R	10SL-3		
	US	-4			RS	-4		
	KT	12-5			KT	12-5		
	KS	12S-3			KS	12S-3		
	W	-4			W	-4		
	K	14S-1			K	14S-1		
		-2				-2		
MS3451	L	-5		9441	F	-5		
MS3452	LS	-6		9442	FS	-6		
MS3454	U	-7		9444	R	-7		
	US	-9			RS	-9		
	W	14-3			W	14-3		
		16S-1				16S-1		
MS3459	L	-8		9816	F	-8		
	LS	16-9			FS	16-9		
	KT	-10			KT	-10		
	KS	-11			KS	-11		
	W	-12			W	-12		
		-13				-13		
		18-1				18-1		
		-4				-4		
		-5*				-5*		
		-6*				-6*		
		-8				-8		
		-9				-9		
		-10				-10		
		-11				-11		
		-12				-12		
		-13				-13		
		18-15**				18-15**		
		-22				-22		
		20-2				20-2		
		-4				-4		
		-7				-7		
		-8				-8		
		-14				-14		
		-15				-15		
		-16				-16		



PREVIOUS GOVERNMENT DESIGNATION AND NON-GOVERNMENT STANDARDS BODIES DESIGNATION	MANUFACTURER'S DESIGNATION	MANUFACTURER'S NAME AND QUALIFICATION TEST REFERENCE
-17	-17	Amphenol Aerospace (continued)
-18	-18	
-19	-19	00101403.AC/07-17-14
-21	-21	
-22	-22	
-24	-24	
-27	-27	
-29	-29	
-33	-33	
22-2	22-2	
-4*	-4*	
-5	-5	
-6	-6	
-7**	-7**	
-14	-14	
-19	-19	
-21	-21	
-22	-22	
-23	-23	
24-1**	24-1**	
-2	-2	
-5	-5	
-7	-7	
-10	-10	
-11	-11	
-12	-12	
-20	-20	
-22	-22	
-28	-28	
28-1	28-1	
-2	-2	
-9	-9	
28-10	28-10	
-11	-11	
-12	-12	
-15	-15	
-17	-17	
-20	-20	
-21	-21	
-22	-22	
32-1	32-1	
-6	-6	
-7	-7	
-9	-9	

PREVIOUS GOVERNMENT DESIGNATION AND NON-GOVERNMENT STANDARDS BODIES DESIGNATION	MANUFACTURER'S DESIGNATION	MANUFACTURER'S NAME AND QUALIFICATION TEST REFERENCE
-13	-13	Amphenol Aerospace (continued)
-15	-15	
-17	-17	00101403.AC/07-17-14
-63	-63	
-73	-73	
36-3	36-3	
-5	-5	
-6	-6	
-7	-7	
-8	-8	
-9	-9	
-10	-10	
-15	-15	
-52	-52	
40-1	40-1	
-9	-9	
-56	-56	

PREVIOUS GOVERNMENT DESIGNATION AND NON-GOVERNMENT STANDARDS BODIES DESIGNATION	MANUFACTURER'S DESIGNATION	MANUFACTURER'S NAME AND QUALIFICATION TEST REFERENCE
---	-------------------------------	---

**SAE-AS50151 SERIES III - CONNECTORS, CRIMP CONTACT, REAR RELEASE  
(continued)**

MS3450	L	8S-1	P	AI3450	L	8S-1	P	Amphenol Interconnect India Pvt. Ltd. Pune  00150106.AA/02-18-2025
MS3456	LS	10S-2	S	AI3456	LS	10S-2	S	
	U	10SL-3			U	10SL-3		
	US	-4			US	-4		
	KT	12S-3			KT	12S-3		
	KS	-4			KS	-4		
	W	12-5			W	12-5		
	K	14S-1			K	14S-1		
		-2				-2		
		-4				-4		
MS3451	L	-5		AI3451	L	-5		
MS3452	LS	-6		AI3452	LS	-6		
MS3454	U	-7		AI3454	U	-7		
	US	-9			US	-9		
	W	14-3			W	14-3		
		16S-1				16S-1		
		-3				-3		
		-4				-4		
		-5				-5		
		-6				-6		
		-8				-8		
		16-2				16-2		
		-7				-7		
MS3459	L	-9		AI3459	L	-9		
	LS	-10			LS	-10		
	KT	-11			KT	-11		
	KS	-12			KS	-12		
	W	-13			W	-13		
		18-1				18-1		
		-3				-3		
		-4				-4		
		-5				-5		
		-6				-6		
		-7				-7		
		-8				-8		
		-9				-9		
		-10				-10		
		-11				-11		
		-12				-12		
		-13				-13		
		-14				-14		

PREVIOUS GOVERNMENT DESIGNATION AND NON-GOVERNMENT STANDARDS BODIES DESIGNATION	MANUFACTURER'S DESIGNATION	MANUFACTURER'S NAME AND QUALIFICATION TEST REFERENCE
-15	-15	Amphenol Interconnect India Pvt. Ltd. Pune  00150106.AA/02-18-2025 (continued)
-16	-16	
-20	-20	
-22	-22	
-29	-29	
20-2	20-2	
-3	-3	
-4	-4	
-5	-5	
-6	-6	
-7	-7	
-8	-8	
-9	-9	
-11	-11	
-12	-12	
-14	-14	
-15	-15	
-16	-16	
-17	-17	
-18	-18	
-19	-19	
-20	-20	
-21	-21	
-22	-22	
-23	-23	
-24	-24	
-27	-27	
-29	-29	
-31	-31	
-33	-33	
22-1	22-1	
-2	-2	
-3	-3	
-4	-4	
-5	-5	
-6	-6	
-7	-7	
-8	-8	
-9	-9	
-10	-10	
-11	-11	
-12	-12	
-13	-13	
-14	-14	
-15	-15	

PREVIOUS GOVERNMENT DESIGNATION AND NON-GOVERNMENT STANDARDS BODIES DESIGNATION	MANUFACTURER'S DESIGNATION	MANUFACTURER'S NAME AND QUALIFICATION TEST REFERENCE
-16	-16	Amphenol Interconnect India Pvt. Ltd. Pune  00150106.AA/02-18-2025 (continued)
-17	-17	
-18	-18	
-19	-19	
-20	-20	
-21	-21	
-22	-22	
-23	-23	
-24	-24	
-25	-25	
-27	-27	
-28	-28	
-29	-29	
-33	-33	
-34	-34	
-36	-36	
-63	-63	
24-1	24-1	
-2	-2	
-3	-3	
-4	-4	
-5	-5	
-6	-6	
-7	-7	
-9	-9	
-10	-10	
-11	-11	
-12	-12	
-14	-14	
-16	-16	
-17	-17	
-20	-20	
-21	-21	
-22	-22	
-23	-23	
-27	-27	
-28	-28	
-80	-80	
28-1	28-1	
-2	-2	
-3	-3	
-4	-4	
-5	-5	
-6	-6	
-8	-8	

PREVIOUS GOVERNMENT DESIGNATION AND NON-GOVERNMENT STANDARDS BODIES DESIGNATION	MANUFACTURER'S DESIGNATION	MANUFACTURER'S NAME AND QUALIFICATION TEST REFERENCE
-09	-09	Amphenol Interconnect India Pvt. Ltd. Pune  00150106.AA/02-18-2025 (continued)
-10	-10	
-11	-11	
-12	-12	
-14	-14	
-15	-15	
-16	-16	
-17	-17	
-18	-18	
-19	-19	
-20	-20	
-21	-21	
-22	-22	
32-1	32-1	
-2	-2	
-3	-3	
-4	-4	
-5	-5	
-6	-6	
-7	-7	
-8	-8	
-9	-9	
-10	-10	
-12	-12	
-13	-13	
-14	-14	
-15	-15	
-17	-17	
-22	-22	
-63	-63	
-73	-73	
36-1	36-1	
-3	-3	
-4	-4	
-5	-5	
-6	-6	
-7	-7	
-8	-8	
-9	-9	
-10	-10	
-13	-13	
-14	-14	
-15	-15	
-19	-19	
-52	-52	

PREVIOUS GOVERNMENT DESIGNATION AND NON-GOVERNMENT STANDARDS BODIES DESIGNATION	MANUFACTURER'S DESIGNATION	MANUFACTURER'S NAME AND QUALIFICATION TEST REFERENCE
-66 40-1	-66 40-1	Amphenol Interconnect India Pvt. Ltd. Pune
-2	-2	00150106.AA/02-18-2025 (continued)
-3	-3	
-4	-4	
-5	-5	
-6	-6	
-7	-7	
-9	-9	
-10	-10	
-11	-11	
-56	-56	
-62	-62	
44-1	44-1	
-52	-52	
48-62	48-62	

PREVIOUS GOVERNMENT DESIGNATION AND NON-GOVERNMENT STANDARDS BODIES DESIGNATION				MANUFACTURER'S DESIGNATION	MANUFACTURER'S NAME AND QUALIFICATION TEST REFERENCE			
<b>SAE-AS50151 SERIES III - CONNECTORS, CRIMP CONTACT, REAR RELEASE</b>								
<b>(continued)</b>								
MS3450	L	8S-1	P	CJ1050	L	8S-1	P	Corsair Electrical
MS3456	LS	10S-2	S	CJ1056	LS	10S-2	S	
MS3459	KT	10SL-3		CJ1059	KT	10SL-3		00138503.AA/07-17-14
	KS	-4			KS	-4		
	W	12S-3			W	12S-3		00138503.AD/07-17-14
		-4				-4		(only corresponds to 32-2)
MS3451	L	12-5		CJ-1051	L	12-5		
MS3452	LS	14S-1		CJ-1052	LS	14S-1		00140708.AA/07-17-14
MS3454	W	-2		CJ-1054	W	-2		(only corresponds to 20-19, 24-5, 32-9 and 32-63)
		-5				-5		
		14S-6				14S-6		
		-7				-7		00140713.AA/07-17-14
		-9				-9		(only corresponds to 22-7, 22-9, 28-10)
		14-3				14-3		
		16S-1				16S-1		
		-4				-4		00140708.AC/07-17-14
		-5				-5		
		-8				-8		
		16-9				16-9		
		-10				-10		
		-11				-11		
		-12				-12		
		18-1				18-1		
		-4				-4		
		-5				-5		
		-6				-6		
		-8				-8		
		-9				-9		
		-10				-10		
		-11				-11		
		-12				-12		
		-20				-20		
		20-1				20-1		
		-2				-2		
		-3				-3		
		-4				-4		
		-7				-7		
		-8				-8		
		-11				-11		
		-14				-14		
		-15				-15		



PREVIOUS GOVERNMENT DESIGNATION AND NON-GOVERNMENT STANDARDS BODIES DESIGNATION	MANUFACTURER'S DESIGNATION	MANUFACTURER'S NAME AND QUALIFICATION TEST REFERENCE
-16		Corsair Electrical (continued)
-17		
-18		
-19		
-20		
-22		
-24		
-27		
-29		
-33		
22-1	22-1	
-2	-2	
-6	-6	
-7	-7	
-9	-9	
-11	-11	
-12	-12	
-13	-13	
-14	-14	
-17	-17	
-18	-18	
-19	-19	
-20	-20	
-21	-21	
-22	-22	
-23	-23	
-27	-27	
-33	-33	
24-2	24-2	
-4	-4	
-5	-5	
-6	-6	
-7	-7	
-9	-9	
-10	-10	
-11	-11	
-12	-12	
-20	-20	
-21	-21	
-22	-22	
-27	-27	
-28	-28	
28-1	28-1	
-2	-2	
-3	-3	

PREVIOUS GOVERNMENT DESIGNATION AND NON-GOVERNMENT STANDARDS BODIES DESIGNATION	MANUFACTURER'S DESIGNATION	MANUFACTURER'S NAME AND QUALIFICATION TEST REFERENCE
-5		Corsair Electrical (continued)
-8		
-10		
-11		
-12		
-15		
-16		
-19		
-20		
-21		
-22		
32-1	32-1	
-2	-2	
-3	-3	
-5	-5	
-6	-6	
-7	-7	
-8	-8	
-9	-9	
-10	-10	
-15	-15	
-17	-17	
-22	-22	
-63	-63	
-73	-73	
36-3	36-3	
-5	-5	
-6	-6	
-7	-7	
-8	-8	
-9	-9	
-10	-10	
40-4	40-4	
-10	-10	
-56	-56	

PREVIOUS GOVERNMENT DESIGNATION AND NON-GOVERNMENT STANDARDS BODIES DESIGNATION	MANUFACTURER'S DESIGNATION	MANUFACTURER'S NAME AND QUALIFICATION TEST REFERENCE
---	-------------------------------	---

**SAE-AS50151 SERIES III - CONNECTORS, CRIMP CONTACT, REAR RELEASE  
(continued)**

MS3450	W	10S-2	P	M3450	W	10S-2	P	ElecSys, Inc.
MS3450	L	10SL-3	S	T3450	L	10SL-3	S	
MS3451	LS	-4		M3451	LS	-4		00125606.AF/07-17-14
MS3451		12S-3		T3451		12S-3		
MS3452		-4		M3452		-4		
MS3452		12-5		T3452		12-5		
MS3454		14S-1		M3454		14S-1		
MS3456		-2		M3456		-2		
MS3456		-4		T3456		-4		
		-5				-5		
MS3450	KT	-6		M3450	KT	-6		
MS3450	KS	-7		T3450	KS	-7		
MS3456		-9		M3456		-9		
		14-3				14-3		
		16S-1				16S-1		
		-3				-3		
		-4				-4		
		-5				-5		
		-6				-6		
		-8				-8		
		16-2				16-2		
		-7				-7		
		-9				-9		
		-10				-10		
		-11				-11		
		-12				-12		
		-13				-13		
		18-1				18-1		
		-4				-4		
		-5				-5		
		-6				-6		
		-7				-7		
		-8				-8		
		-9				-9		
		-10				-10		
		-11				-11		
		-12				-12		
		-14				-14		
		-20				-20		
		-22				-22		
		-29				-29		

PREVIOUS GOVERNMENT DESIGNATION AND NON-GOVERNMENT STANDARDS BODIES DESIGNATION	MANUFACTURER'S DESIGNATION	MANUFACTURER'S NAME AND QUALIFICATION TEST REFERENCE
20-2	20-2	ElecSys, Inc. (continued)
-3	-3	
-4	-4	00125606.AF/07-17-14
-5	-5	
-6	-6	
-7	-7	
-8	-8	
-11	-11	
-14	-14	
-15	-15	
-16	-16	
-17	-17	
-18	-18	
-19	-19	
-20	-20	
-21	-21	
-22	-22	
-23	-23	
-24	-24	
-27	-27	
20-29	20-29	
-30	-30	
-33	-33	
22-1	22-1	
-2	-2	
-3	-3	
-4	-4	
-5	-5	
-6	-6	
-7	-7	
-8	-8	
-9	-9	
-10	-10	
-12	-12	
-13	-13	
-14	-14	
-15	-15	
-16	-16	
-17	-17	
-18	-18	
-19	-19	
-20	-20	
-21	-21	
-22	-22	
-23	-23	

PREVIOUS GOVERNMENT DESIGNATION AND NON-GOVERNMENT STANDARDS BODIES DESIGNATION	MANUFACTURER'S DESIGNATION	MANUFACTURER'S NAME AND QUALIFICATION TEST REFERENCE
-24	-24	ElecSys, Inc. (continued)
-27	-27	
-28	-28	00125606.AF/07-17-14
-29	-29	
-34	-34	
-36	-36	
24-2	24-2	
-4	-4	
-5	-5	
-6	-6	
-7	-7	
-9	-9	
-10	-10	
-11	-11	
-12	-12	
-14	-14	
24-16	24-16	
-20	-20	
-21	-21	
-22	-22	
-27	-27	
-28	-28	
28-1	28-1	
-2	-2	
-3	-3	
-4	-4	
-5	-5	
-6	-6	
-8	-8	
-9	-9	
-10	-10	
-11	-11	
-12	-12	
-14	-14	
-15	-15	
-16	-16	
-17	-17	
-18	-18	
-19	-19	
-20	-20	
-21	-21	
-22	-22	
32-1	32-1	
-2	-2	
-3	-3	

PREVIOUS GOVERNMENT DESIGNATION AND NON-GOVERNMENT STANDARDS BODIES DESIGNATION	MANUFACTURER'S DESIGNATION	MANUFACTURER'S NAME AND QUALIFICATION TEST REFERENCE
-5	-5	ElecSys, Inc. (continued)  00125606.AF/07-17-14
-6	-6	
-7	-7	
-8	-8	
-9	-9	
-10	-10	
-12	-12	
-13	-13	
-14	-14	
-15	-15	
-17	-17	
-63	-63	
36-1	36-1	
-3	-3	
-4	-4	
-5	-5	
-6	-6	
-7	-7	
-8	-8	
-9	-9	
-10	-10	
-14	-14	
-15	-15	
-52	-52	
40-1	40-1	
-5	-5	
-11	-11	
-56	-56	
-62	-62	
44-1	44-1	

PREVIOUS GOVERNMENT DESIGNATION AND NON-GOVERNMENT STANDARDS BODIES DESIGNATION			MANUFACTURER'S DESIGNATION			MANUFACTURER'S NAME AND QUALIFICATION TEST REFERENCE
<b>SAE-AS50151 SERIES III - CONNECTORS, CRIMP CONTACT, REAR RELEASE</b>						
<b>(continued)</b>						

MS3450	U	8S-1	P	CV3450	U	8S-1	P	ITT Cannon  00112906.AJ/07-17-14  * This insert arrangement available in Style S only.  ** This insert arrangement available in Style P only  .
MS3456	KT	10S-2	S	CV3456	KT	10S-2	S	
	KS	10SL-3			KS	10SL-3		
	LS	-4			LS	-4		
	US	12S-3			US	12S-3		
	W	12-5			W	12-5		
	K	14S-2			K	14S-2		
		-5				-5		
		-6				-6		
MS3451	U	-7		CV3451	U	-7		
MS3454	W	-9		CV3454	W	-9		
	LS	16S-1			LS	16S-1		
	US	-4			US	-4		
		-8				-8		
		16-7				16-7		
		-9				-9		
		-10				-10		
		-11				-11		
		18-1				18-1		
		-4				-4		
		-8				-8		
		-9				-9		
		-10				-10		
		-11				-11		
		-12				-12		
		-22				-22		
		-22*				-22*		
		20-2				20-2		
		-4				-4		
		-7				-7		
		-14				-14		
		-15				-15		
		-16				-16		
		-18				-18		
		-27				-27		
		-29				-29		
		22-2				22-2		
		-5				-5		
		-13*				-13*		
		-14				-14		
		-16				-16		

PREVIOUS GOVERNMENT DESIGNATION AND NON-GOVERNMENT STANDARDS BODIES DESIGNATION	MANUFACTURER'S DESIGNATION	MANUFACTURER'S NAME AND QUALIFICATION TEST REFERENCE
-18**	-18**	ITT Cannon (continued)
-19*	-19*	
-22	-22	00112906.AJ/07-17-14
24-4	24-4	
-7	-7	* This insert arrangement available in Style S only.
-10	-10	
-11	-11	** This insert arrangement available in Style P only
-20*	-20*	
-22	-22	00112906.AJ/07-17-14
-28	-28	
28-2	28-2	* This insert arrangement available in Style S only.
-9	-9	
-11	-11	** This insert arrangement available in Style P only
-12	-12	
-15	-15	00112906.AJ/07-17-14
-17	-17	
-18*	-18*	* This insert arrangement available in Style S only.
-21	-21	
32-6	32-6	** This insert arrangement available in Style P only
-7	-7	
-9	-9	00112906.AJ/07-17-14
-12	-12	
-13	-13	* This insert arrangement available in Style S only.
-17	-17	
36-3	36-3	** This insert arrangement available in Style P only
-5	-5	
-6	-6	00112906.AJ/07-17-14
-7	-7	
-8	-8	* This insert arrangement available in Style S only.
-10	-10	
-52	-52	** This insert arrangement available in Style P only
40-1	40-1	



PREVIOUS GOVERNMENT DESIGNATION AND NON-GOVERNMENT STANDARDS BODIES DESIGNATION	MANUFACTURER'S DESIGNATION	MANUFACTURER'S NAME AND QUALIFICATION TEST REFERENCE
---	-------------------------------	---

**SAE-AS50151 SERIES III - CONNECTORS, CRIMP CONTACT, REAR RELEASE  
(continued)**

MS3450	L	8S-1	P	JT3450	L	8S-1	P	J-Tech, Inc.
MS3456	LS	10S-2	S	JT3456	LS	10S-2	S	
MS3451	L	10SL-3		JT3451	L	10SL-3		00113406.AD/07-17-14
MS3452	LS	-4		JT3452	LS	-4		
MS3454	W	12S-3		JT3454	W	12S-3		
		12-5				12-5		
		14S-2				14S-2		
		-5				-5		
		-6				-6		
		-7				-7		
		-9				-9		
		16S-1				16S-1		
		-4				-4		
		-5				-5		
		-8				-8		
		16-9				16-9		
		-10				-10		
		-11				-11		
		18-1				18-1		
		-3				-3		
		-4				-4		
		-6				-6		
		-8				-8		
		-9				-9		
		-10				-10		
		-11				-11		
		-12				-12		
		-20				-20		
		-22				-22		
		20-3				20-3		
		-4				-4		
		20-6				20-6		
		-7				-7		
		-9				-9		
		-11				-11		
		-14				-14		
		-15				-15		
		-16				-16		
		-17				-17		
		-18				-18		
		-19				-19		
		-22				-22		

PREVIOUS GOVERNMENT DESIGNATION AND NON-GOVERNMENT STANDARDS BODIES DESIGNATION	MANUFACTURER'S DESIGNATION	MANUFACTURER'S NAME AND QUALIFICATION TEST REFERENCE
-27	-27	
-29	-29	
-33	-33	
22-2	22-2	
-5	-5	J-Tech, Inc.
-7	-7	(continued)
-9	-9	
-10	-10	00113406.AD/07-17-14
-11	-11	
-13	-13	
-14	-14	
-15	-15	
-16	-16	
-18	-18	
-19	-19	
-22	-22	
-23	-23	
-27	-27	
-28	-28	
-33	-33	
24-2	24-2	
-4	-4	
-5	-5	
-6	-6	
-7	-7	
-9	-9	
-10	-10	
-11	-11	
-12	-12	
-22	-22	
24-27	24-27	
-28	-28	
-80	-80	
28-1	28-1	
-6	-6	
-8	-8	
-9	-9	
-10	-10	
-11	-11	
-12	-12	
-15	-15	
-16	-16	
-17	-17	
-18	-18	
-20	-20	

PREVIOUS GOVERNMENT DESIGNATION AND NON-GOVERNMENT STANDARDS BODIES DESIGNATION	MANUFACTURER'S DESIGNATION	MANUFACTURER'S NAME AND QUALIFICATION TEST REFERENCE
-21	-21	
-22	-22	
32-6	32-6	
-7	-7	
-8	-8	J-Tech, Inc.
-13	-13	(continued)
-17	-17	
-22	-22	
-73	-73	
36-7	36-7	
-8	-8	
-9	-9	
-10	-10	
-15	-15	
-66	-66	
40-1	40-1	
-9	-9	
-10	-10	
-56	-56	
-62	-62	

PREVIOUS GOVERNMENT DESIGNATION AND NON-GOVERNMENT STANDARDS BODIES DESIGNATION	MANUFACTURER'S DESIGNATION	MANUFACTURER'S NAME AND QUALIFICATION TEST REFERENCE
---	-------------------------------	---

**SAE-AS50151 SERIES IV – CONNECTOR ACCESSORIES**

**MS25042 AND MS25043 PART NUMBER EXAMPLE, OPTIONS, AND DESCRIPTIONS**

**Reference: latest issues of AS25042 and AS25043**

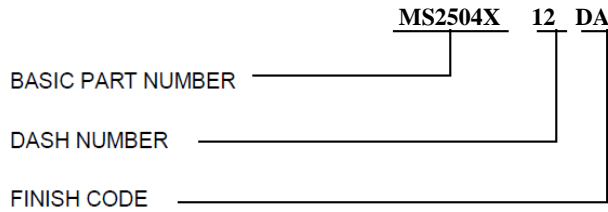

Dash Number: Per latest issue of AS2504X.

Finish Code: Per latest issue of AS2504X.

PREVIOUS GOVERNMENT DESIGNATION AND NON-GOVERNMENT STANDARDS BODIES DESIGNATION	MANUFACTURER'S DESIGNATION	MANUFACTURER'S NAME AND QUALIFICATION TEST REFERENCE
---	-------------------------------	---

**SAE-AS50151 SERIES IV – CONNECTOR ACCESSORIES (continued)**

MS25042	-8	D	AE542	-8	D	Aero-Electric
MS25043	-10	DA	AE543	-10	DA	
	-12			-12		00100606.AC/07-17-14
	-14			-14		
	-16			-16		
	-18			-18		
	-20			-20		
	-22			-22		
	-24			-24		
	-28			-28		
	-32			-32		
	-36			-36		
	-40			-40		
	-44			-44		

PREVIOUS GOVERNMENT DESIGNATION AND NON-GOVERNMENT STANDARDS BODIES DESIGNATION		MANUFACTURER'S DESIGNATION		MANUFACTURER'S NAME AND QUALIFICATION TEST REFERENCE
---	--	-------------------------------	--	---

**SAE-AS50151 SERIES IV – CONNECTOR ACCESSORIES (continued)**

M25042	-10	DA	10-472958	-10	2	Amphenol Aerospace
M25043	-12		10-472959	-12		
	-14			-14		00101406.AA/07-17-14
	-16			-16		
	-18			-18		
	-20			-20		
	-22			-22		
	-24			-24		
	-28			-28		
	-32			-32		
	-36			-36		
	-40			-40		

M25042	-8	D	AI25042	-8	D	Amphenol Interconnect
M25043	-10	DA	AI25043	-10	DA	India Pvt. Ltd. Pune
	-12	DZ		-12	DZ	
	-14			-14		00150106.AA/02-18-2025
	-16			-16		
	-18			-18		
	-20			-20		
	-22			-22		
	-24			-24		
	-28			-28		
	-32			-32		
	-36			-36		
	-40			-40		
	-44			-44		
	-48			-48		

PREVIOUS GOVERNMENT DESIGNATION AND NON-GOVERNMENT STANDARDS BODIES DESIGNATION			MANUFACTURER'S DESIGNATION			MANUFACTURER'S NAME AND QUALIFICATION TEST REFERENCE
M25042	-8	D	A25042	-8	D	Amphenol Interconnect India Bangalore  00140912.AA/07-17-14
M25043	-10	DA	A25043	-10	DA	
	-12	DZ		-12	DZ	
	-14			-14		
	-16			-16		
	-18			-18		
	-20			-20		
	-22			-22		
	-24			-24		
	-28			-28		
	-32			-32		
	-36			-36		
	-40			-40		
	-44			-44		
	-48			-48		

PREVIOUS GOVERNMENT DESIGNATION AND NON-GOVERNMENT STANDARDS BODIES DESIGNATION			MANUFACTURER'S DESIGNATION			MANUFACTURER'S NAME AND QUALIFICATION TEST REFERENCE
<b>SAE-AS50151 SERIES IV – CONNECTOR ACCESSORIES (continued)</b>						
MS25042	-8	DA	660-004	C	08S4-05	Glenair, Inc.
	-10	D		NF	10S4-05	
	-12	DT		MT	12S4.5-05	00110204.AF/07-17-14
	-14	DY		AL	14S4.5-05	
	-16	DZ		ZR	16S4.5-05	
	-18				18S4.5-05	
	-20				20S5-02	
	-22				22S5-02	
	-24				24S5.5-02	
	-28				28S7.75-02	
	-32				32S7.75-04	
	-36				36S7.75-04	
	-40				40S7.75-04	
	-44				44S7.75-04	
	-48				48S7.75-04	
MS25043	-8	DA	660-005	C	08S4-01	Glenair, Inc.
	-10	D		NF	10S4-01	
	-12	DT		MT	12S4.5-01	00110204.AF/07-17-14
	-14	DY		AL	14S4.5-01	
	-16	DZ		ZR	16S4.5-01	
	-18				18S4.5-01	
	-20				20S5-01	
	-22				22S5-01	
	-24				24S5.5-05	
	-28				28S7.75-05	
	-32				32S7.75-02	
	-36				36S7.75-02	
	-40				40S7.75-02	
	-44				44S7.75-02	
	-48				48S7.75-02	



PREVIOUS GOVERNMENT DESIGNATION AND NON-GOVERNMENT STANDARDS BODIES DESIGNATION			MANUFACTURER'S DESIGNATION		MANUFACTURER'S NAME AND QUALIFICATION TEST REFERENCE
<b>SAE-AS50151 SERIES IV – CONNECTOR ACCESSORIES (continued)</b>					
MS25042	-8 -10 -12 -14 -16 -18 -20 -22 -24 -28 -32 -36 -40 -44 -48	DA	SA90A	01C4.0-8 05C4.0-8 09C4.5-8 11C4.5-8 15C4.5-8 19C4.5-8 23C5.0-4-8 27C5.0-4-8 31C5.5-4-8 35C7.75-4-8 37C7.75-6-8 39C7.75-6-8 41C7.75-6-8 43C7.75-6-8 45C7.75-6-8	Eaton Aerospace  00130604.AG/07-17-14
MS25043	-8 -10 -12 -14 -16 -18 -20 -22 -24 -28 -32 -36 -40 -44 -48	DA	SE90A	02C4.0-8 06C4.0-8 10C4.5-8 12C4.5-8 16C4.5-8 20C4.5-8 24C5.0-8 28C5.0-8 32C5.5-4-8 36C7.75-4-8 38C7.75-4-8 40C7.75-4-8 42C7.75-4-8 44C7.75-4-8 46C7.75-4-8	Eaton Aerospace  00130604.AG/07-17-14

PREVIOUS GOVERNMENT DESIGNATION AND NON-GOVERNMENT STANDARDS BODIES DESIGNATION	MANUFACTURER'S DESIGNATION	MANUFACTURER'S NAME AND QUALIFICATION TEST REFERENCE
---	-------------------------------	---

**SAE-AS50151 SERIES IV – CONNECTOR ACCESSORIES (continued)**

M25042	-8	D	SCP25042	-8	D	Spacecraft Component Corp
M25043	-10	DA	SCP25043	-10	DA	
	-12			-12		00140309.AA/07-17-14
	-14			-14		
	-16			-16		
	-18			-18		
	-20			-20		
	-22			-22		
	-24			-24		
	-28			-28		
	-32			-32		
	-36			-36		
	-40			-40		
	-44			-44		
	-48			-48		

PREVIOUS GOVERNMENT DESIGNATION AND NON-GOVERNMENT STANDARDS BODIES DESIGNATION	MANUFACTURER'S DESIGNATION	MANUFACTURER'S NAME AND QUALIFICATION TEST REFERENCE
---	-------------------------------	---

**SAE-AS50151 SERIES IV – CONNECTOR ACCESSORIES (continued)**

**MS3105 PART NUMBER EXAMPLE, OPTIONS, AND DESCRIPTIONS**

**Reference: latest issues of AS31051**



Shell Size: Per latest issue of AS31051.

PREVIOUS GOVERNMENT DESIGNATION AND NON-GOVERNMENT STANDARDS BODIES DESIGNATION	MANUFACTURER'S DESIGNATION	MANUFACTURER'S NAME AND QUALIFICATION TEST REFERENCE
---	-------------------------------	---

**SAE-AS50151 SERIES IV – CONNECTOR ACCESSORIES (continued)**

MS3105	-8S -10S -12 -12S -14 -14S -16 -16S -18 -20 -22 -24 -28 -32 -36 -40 -44 -48	AI3105	-8S -10S -12 -12S -14 -14S -16 -16S -18 -20 -22 -24 -28 -32 -36 -40 -44 -48	Amphenol Interconnect India Pvt. Ltd. Pune  00150106.AA/02-18-2025
--------	--	--------	--	---

MS3105	-8S -10S -12 -12S -14 -14S -16 -16S -18 -20 -22 -24 -28 -32 -36 -40 -44 -48	650BS001B	-8S -10S -12 -12S -14 -14S -16 -16S -18 -20 -22 -24 -28 -32 -36 -40 -44 -48	Glenair, Inc.  00110204.AF/07-17-14
--------	--	-----------	--	---

PREVIOUS GOVERNMENT DESIGNATION AND NON-GOVERNMENT STANDARDS BODIES DESIGNATION		MANUFACTURER'S DESIGNATION	MANUFACTURER'S NAME AND QUALIFICATION TEST REFERENCE	
MS3105	-8S -10S -12 -12S -14 -14S -16 -16S -18 -20 -22 -24 -28 -32 -36 -40 -44 -48	SCP3105	-8S -10S -12 -12S -14 -14S -16 -16S -18 -20 -22 -24 -28 -32 -36 -40 -44 -48	Spacecraft Component Corp  00140309.AA/07-17-14

MANUFACTURER'S OFFICE ADDRESS (Where contracts are received)	MANUFACTURER'S PLANT ADDRESS (Primary source of manufacturing & control)
---	---

Aero-Electric Connector, Inc.  
 2280 W 208<sup>th</sup> ST  
 Torrance, CA 90501

Cage Code: 59976

Plant: Same address

---

Assembly Plants:

A.E. Petsche Co.  
 Blvd, Luis Donaldo Colosio #1179  
 Col. Obreras, C.P. 84048  
 Nogales, Sonora Mexico

Cage Code: SWU36

---

Benchmark Connector Corp.  
 4501 NW 103rd Avenue, Suite 101  
 Sunrise, FL 33351

Cage Code: 08MA2

---

BTC Electronic Components  
 2709 Connector Drive  
 Wake Forest, NC 27587

Cage Code: 63365

---

Circular Connectors  
 3250 Coreto Malpaso  
 Camarillo, CA 93012-8000

Cage Code: 0JY08

---

Electronic Connector Company  
 5225 Thatcher Blvd.  
 Downers Grove, IL 60515

Cage Code: 2B570

---

MANUFACTURER'S OFFICE ADDRESS (Where contracts are received)	MANUFACTURER'S PLANT ADDRESS (Primary source of manufacturing & control)
---	---

Aero-Electric Connector, Inc. (continued)

Heilind Mil-Aero  
 100C Mount Holly Bypass  
 Lumberton, NJ 08048

Cage Code: 1DJ61

---

Kirkhill Aircraft Parts Company (Proponent)  
 10601 State St. – Suite 1  
 Tamarac, FL 33321

Cage Code: 91NTA

---

PEI-Genesis  
 4747 West Cleveland Road  
 South Bend, IN 46628

Cage Code: 2A589

---

Powell Electronics  
 200 Commodore Drive  
 Swedesboro, NJ 08085

Cage Code: 20441

---

TTI  
 3737 Meacham Blvd  
 Fort Worth, TX 76106

Cage Code: 7HGG5

---

Wesco Aircraft  
 3851 North Webb Road  
 Wichita, KS 67226

Cage Code: 6M266

---

MANUFACTURER'S OFFICE ADDRESS (Where contracts are received)	MANUFACTURER'S PLANT ADDRESS (Primary source of manufacturing & control)
---	---

WireMasters Mexico  
 Calle El Dorado Numero 98  
 Interior A, Parque Industrial El Dorado  
 Mexicali Baja California, C.P. 21383

Cage Code: SHTG6

Amphenol Aerospace  
 40-60 Delaware Avenue  
 Sidney, NY 13838-1304

Cage Code: 77820

Plant: Same address

Assembly Plants:

Amphenol Aerospace/Amphenol Optimize  
 (Mexico)  
 Calle Los Gavilanes #51  
 Parque Industrial San Ramon  
 Nogales, Sonora CP 84094, MX

Cage Code: SKCJ5

Amphenol Aerospace/Amphenol Optimize  
 (Mexico)  
 San Patricio Numero EXT. L-6 Numero INT P-  
 2  
 Col Parque Ind San Carlos CP 84090  
 Nogales, Sonora

Cage Code:

Category C Authorized Distributors:

Arrow Electronics, Inc.  
 Blvd Luis Donaldo Colosio #1179  
 Col. Obreras,, C.P. 84048  
 Nogalas, Sonora Mexico

Cage Code: 59L01



MANUFACTURER'S OFFICE ADDRESS (Where contracts are received)	MANUFACTURER'S PLANT ADDRESS (Primary source of manufacturing & control)
---	---

FDH Electronics, LLC  
141 Remington Blvd  
Ronkonkoma, NY 11779

Cage Code: 0DTU2

---

Amphenol Aerospace (continued)

Heilind Mil-Aero LLC  
100C Mount Holly Bypass  
Lumbertown, NJ 08048

Cage Code: 1DJ61

---

PEI-Genesis  
4747 West Cleveland Road  
South Bend, IN 46628

Cage Code: 2A589

---

Powell Electronics  
200 Commodore Drive  
Swedesboro, NJ 08085

Cage Code: 20441

---

Quittner & Schimek, s.r.o  
Podlevinska 518  
50791 Stara Paka  
Czech Republic

Cage Code: 0416G

---

TTI  
3737 Meacham Blvd  
Fort Worth, TX 76106

Cage Code: 7HGG5

---

MANUFACTURER'S OFFICE ADDRESS (Where contracts are received)	MANUFACTURER'S PLANT ADDRESS (Primary source of manufacturing & control)
---	---

Wesco Aircraft  
 Electronic Products Group  
 3851 North Webb Road  
 Wichita, KS 67226

Cage Code: 6M266

Amphenol Interconnect India Private Limited  
 Plot #61, Keonics Electronic City  
 Hosur Road. Bangalore 560 100

Plant: Same address

Cage Code: 0950Y

Amphenol Interconnect India Pvt. Ltd. Pune  
 105, Bhosari Industrial Area  
 Pune – 411026, India

Plant: Same address

Cage Code: 1433Y

Corsair Electrical Connectors, Inc.  
 17100 Murphy Avenue  
 Irvine, CA 92614

Plant: Same address

Cage Code: 1R6R9

Assembly Plants:

A.E. Petsche Co.  
 Blvd, Luis Donaldo Colosio #1179  
 Col. Obreras, C.P. 84048  
 Nogales, Sonora Mexico

Cage Code: SWU36

Air Electric, Inc.  
 9452 De Soito Avenue  
 Chatsworth, CA 91313-2231

Cage Code: 1E559

MANUFACTURER'S OFFICE ADDRESS (Where contracts are received)	MANUFACTURER'S PLANT ADDRESS (Primary source of manufacturing & control)
---	---

Arrow Electronics, Inc. Departamento  
 Sonitronics, S.A. De C.V  
 Blvd, Luis Donaldo Colosio #1179  
 Col. Obreras,, C.P. 84048  
 Nogalas, Sonora Mexico

Cage Code: 0S466

---

FDH Electronics, LLC  
 141 Remington Blvd  
 Ronkonkoma, NY 11779

Cage Code: 0DTU2

---

Boeing Distribution Services  
 10900 E. 26<sup>th</sup> Street North,  
 Wichita, KS 67226

Cage Code: 4YN29

---

Corsair Electrical Connectors, Inc. (continued)

Brandex Components  
 10440 NW 50<sup>th</sup> Street  
 Fort Lauderdale, FL 33351

Cage Code: 04NT4

---

CDM Electronics, Inc.  
 130 American Boulevard  
 Turnersville, NJ 08012

Cage Code: 42827

---

Connective Design Inc.  
 3010 S. Tech Blvd.  
 Miamisburg, OH 45342

Cage Code: 0PCR1

---

FDH Electronics, LLC  
 3601 N. Interstate 35

MANUFACTURER'S OFFICE ADDRESS (Where contracts are received)	MANUFACTURER'S PLANT ADDRESS (Primary source of manufacturing & control)
---	---

Oklahoma City, OK 73111

Cage Code: 4H538

---

Corsair Electrical Connectors Mexico  
 Calle Maple No. 101,  
 Col Parque Industrial, Tecate  
 Baja California, 21430, Mexico

Cage Code: SHKX7

---

J&K Connectors  
 1600 SW 43<sup>rd</sup> St. #100  
 Renton, WA 98057

Cage Code: 6L529

---

Corsair Electrical Connectors, Inc. (continued)

Spacecraft Components  
 3040 N. Clayton St.  
 Las Vegas, NV 89032

Cage Code: 2B618

---

WireMasters Mexicali  
 Calle El Dorado Numero 98 Interior A,  
 Parque Industrial El Dorado Mexicali  
 Baja California, C.P. 21383, Mexico

Cage Code: SHTG6

---

Eaton Aerospace  
 1740 Commerce Way  
 Paso Robles, CA 93446

Plant: Same address

Cage Code: 07418

---

MANUFACTURER'S OFFICE ADDRESS (Where contracts are received)	MANUFACTURER'S PLANT ADDRESS (Primary source of manufacturing & control)
---	---

ElecSys, Inc.  
 Division of DCX-CHOL  
 225 Enterprise Drive  
 Pekin, IL 61554

Cage Code: 30463

Plant: Same address

---

Assembly Plants:

Benchmark Connector Corp.  
 4501 NW 103rd Avenue, Suite 101  
 Sunrise, FL 33351

Cage Code: 08MA2

---

Spacecraft Component Corp  
 3040 N. Clayton St. North  
 Las Vegas, NV 89032

Cage Code: 2B618

---

Glenair, Inc.  
 1211 Air Way  
 Glendale, CA 91201-2405

Cage Code: 06324

Plant: Same address

---

MANUFACTURER'S OFFICE ADDRESS (Where contracts are received)	MANUFACTURER'S PLANT ADDRESS (Primary source of manufacturing & control)
---	---

ITT Cannon  
 56 Technology Dr  
 Irvine, CA 92618-2301

Cage Code: 71468

Plant:

ITT Cannon Nogales  
 Avenida del Libre Comercio S/N  
 Parque Industrial Nuevo Nogales  
 Nogales Sonora, Mexico 84093

Cage Code: SB794

---

Assembly Plants:

Arrow Electronics, Inc. Departamento  
 Sonitronies, S.A. De C.V  
 Blvd, Luis Donaldo Colosio #1179  
 Col. Obreras,, C.P. 84048  
 Nogalas, Sonora Mexico

Cage Code: 0S466

---

TTI  
 3737 Meacham Blvd  
 Fort Worth, TX 76106

Cage Code: 7HGG5

---

MANUFACTURER'S OFFICE ADDRESS (Where contracts are received)	MANUFACTURER'S PLANT ADDRESS (Primary source of manufacturing & control)
---	---

J-Tech  
 2280 W. 208<sup>th</sup> Street  
 Torrance, CA 90501

Cage Code: 0BW78

Plant: Same address

---

Assembly Plants:

Heilind Mil-Aero LLC  
 100C Mount Holly Bypass  
 Lumbertown, NJ 08048

Cage Code: 1DJ61

---

Proponent  
 11300 Fortune Circle  
 Wellington, FL 33414

Cage Code: 59789

---

Powell Electronics  
 200 Commodore Drive  
 Swedesboro, NJ 08085

Cage Code: 20441

---

TTI  
 3737 Meacham Blvd  
 Fort Worth, TX 76106

Cage Code: 7HGG5

---

WireMasters Mexico  
 Calle El Dorado Numero 98  
 Interior A, Parque Industrial El Dorado  
 Mexicali Baja California, C.P. 21383

Cage Code: SHTG6

---

MANUFACTURER'S OFFICE ADDRESS (Where contracts are received)	MANUFACTURER'S PLANT ADDRESS (Primary source of manufacturing & control)
---	---

Spacecraft Component Corp  
3040 N. Clayton St. North  
Las Vegas, NV 89032

Plant: Same address

Cage Code: 2B618

---